

Window and Door Technology



Roto Outward Opening

Hardware systems
for outward opening windows

Catalogue
for timber, PVC and aluminium profiles

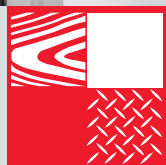

german made

What does that mean?



The company Roto with headquarters in Leinfelden-Echterdingen near Stuttgart is a German group of companies. Roto has grown robustly – organically and consistently.

Our common values represent an identity that has enabled Roto, as a German company, to become a service leader. The value structure of our company is based on three pillars:

- Continuity, consistency and reliability
- Experience, ambition to succeed and vision
- Knowledge, ability and German engineering skills

As a technological pioneer, Roto develops intelligent product solutions that feature impressively precise technology and long service life.

Production and environmental management as well as logistics, irrespective of the manufacturing country, are based on German values such as reliability, thoroughness and vision.

German precision in design and development as well as quality and process management guarantee that we can provide outstanding performance and high-quality services – worldwide.

The consistent implementation of German values in quality specifications and standards ensures that our partners and customers can place their trust in us. This is "german made".

Company



The company Roto, based in Leinfelden-Echterdingen near Stuttgart, is a German group of companies that is wholly owned by families descended from the company's founder, Wilhelm Frank.

The group comprises three independent divisions which develop and produce hardware systems, roof windows and stairs for the construction industry and offer sophisticated services relating to windows and doors.

The Roto name has represented an inventive spirit and technological progress in compatible components for the construction industry since 1935.

The Roto Group is active all over the world with an extensive business portfolio and around 5000 employees.

Roto works on the basis of clear management and conduct principles to secure the position of the group as a success story and to ensure continued success.

Roto is inspired by the needs and expectations of customers, whether you are a builder, planner, architect, manufacturer or retailer of windows and doors, or manufacturer or specialist retailer for roofing.

Roto | Window and Door Technology

Worldwide



Europe



Roto Frank Austria GmbH

Kalsdorf (AT)



Roto Frank Belarus

Minsk (BY)



Roto Frank S.A.

Nivelles (BE)



Roto Frank GmbH

Dietikon (CH)



Roto Frank Fenster- und Türtechnologie GmbH

Leinfelden / Velbert (DE)



Roto Frank Ehitusrautised OÜ

Tallinn (EE)



Roto Frank S.A.

Lliçà de Vall (ES)



Roto Frank Ferrures S.A.S.

Saint Avold (FR)



Roto Elzett Certa Kft.

Lövő / Sopron (HU)



Roto Frank Italia

San Donà di Piave (IT)



Roto Frank Lithuania

Vilnius (LT)



Roto Frank Latvijā

Jūrmala (LV)





Roto Frank
Warsaw (PL)



Roto Romania S.R.L.
Bucharest (RO)



OOO Roto Frank
Noginsk (RU)



Roto Frank Ltd. Sti.
Istanbul (TR)



Roto Frank Okucia Budowlane Sp. z o.o.
Kiev (UA)



Asia



Roto Frank Building Materials Co. Ltd.
Beijing (CN)



Roto Frank Indonesia
Jakarta (ID)



Roto Frank Asia – Pacific Liaison Office India
Mumbai (IN)



Roto Frank Asia-Pacific Pte. Ltd
Singapore (SG)



Roto Frank Asia-Pacific Pte. Ltd.
Hanoi (VN)



America



Roto Frank Latina SA
Buenos Aires (ARG)



Roto Frank Brasil Ltd.
San Jose (BR)



Fermax Componentes Ltd.
Colombo (BR)



Roto Fasco Canada Inc.
Mississauga, Ontario (CA)



Roto Frank Chile
Santiago (CL)



Roto Frank of America Inc.
Chester (US)



= Sales = Production / sales

Information	10
Stay systems	34
Locking systems	88



General		Further Roto products	
Material	10	Roto Window	28
Opening types	10	Roto Sliding	29
Product features	11	Roto Door	30
Colours	13	Roto Equipment	31
Abbreviations	13		
Copyright protection	14	Contact	
		See page	32
Outward Opening			
Opening types	15		
Scissor stay systems	16		
Locking systems	16		
Profile sections	18		
Storage conditions			
See page	20		
Environment			
See page	21		
Gütegemeinschaft Schlösser und Beschläge e.V.			
See page	22		
Certifications			
Quality management	23		
International Technology Centre (ITC)	24		
Roto Con Orders			
See page	25		
Roto media portal			
See page	27		



1 Information

1.1 General









INFO



All dimensions stated in millimetres. Other values are specified.

The following markings are used in this document.

1.1.1 Material

Symbol	Meaning
Material	
	Timber
	PVC
	Aluminium
	Timber and aluminium
	Timber and PVC
	Timber, PVC and aluminium
	Timber, timber-aluminium

1.1.2 Opening types

Symbol	Meaning
	Side-Hung
	Top-Hung
	Top-Swing
	Parallel opening

1.1.3 Product features

Symbol	Meaning
	Hardware axis
	Description
	DIN left / right
	Backset
	Rebate clearance
	Rebate depth
	Colour code
	Colour
	Sash width
	Sash weight
	Sash height
	Fixed handle height
	Centred / variable handle height
	Height
	Information
	Couplable
	Length
	Material
	Material number



Symbol	Meaning
	Maximum
	Minimum
	Installation type
	Surface
	Opening type
	Opening angle
	Opening width
	Position
	Profile manufacturer
	Profile system
	Frame groove
	Roto logo
	Scissor stay length
	Scissor stay width
	Number of locking cams
	Locking cam height
	Type of locking cams
	Stack height
	System
	Packaging unit



1.1.4 Colours

Colour code, Roto	Colour code, standard	Colour
R01.1	–	Natural silver
R01.2	–	Nickel silver
R01.3	–	Titanium
R01.4	–	Chromium
R01.5	–	Silver
R02.2	RAL 7016	Anthracite grey
R03.1	–	Brass matt
R03.2	–	Brass, polished
R03.3	–	Gold
R03.4	–	Stainless-steel design
R04.1	RAL 8019	Grey brown
R04.3	–	Olive brown
R04.4	RAL 8022	Black brown
R05.3	–	Medium bronze
R05.4	–	Dark bronze
R05.5	–	Bronze
R06.2M	RAL 9005, matt	Jet black, matt
R06.2	RAL 9005	Jet black
R06.4M	–	Black, matt
R07.1	RAL 9010	Pure white
R07.2	RAL 9016	Traffic white
R07.3	RAL 9001	Cream
SP. COL.	SP. COL.	Special colour
Untreated	Untreated	Uncoated

Colour examples

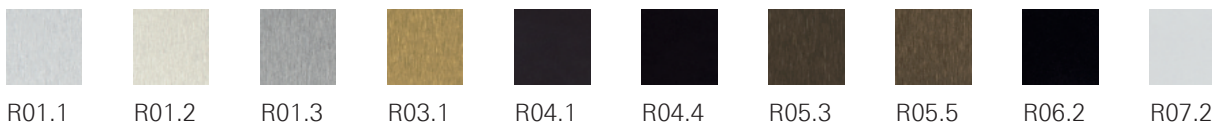

R01.1 R01.2 R01.3 R03.1 R04.1 R04.4 R05.3 R05.5 R06.2 R07.2



INFO

Colours may deviate in the illustration.

1.1.5 Abbreviations

Abbreviation	Meaning
BS	British Standard
CTL	Catalogue
DIN L / R	DIN left / right
EN	European standard
F	Ferritic
SW	Sash width
S.kg	Sash weight
SH	Sash height
SRW	Sash rebate width
SRH	Sash rebate height
IMO	Installation, maintenance and operating instructions
ITC	International Technology Centre
kg	Kilograms
L	Left
M	Metres
mm	Millimetres



Abbreviation	Meaning
Max.	Maximum
N	Newtons
Nm	Newton metres
Not sh.	Not shown
R	Right
RC	Resistance class
SH	Side-Hung
TH	Top-Hung
e.g.	For example

1.1.6 Copyright protection

The contents of this document are copyright-protected. This content can be used when working with the hardware. Any other use is not permitted without written permission of the manufacturer.

1.2 Outward Opening

The product range for outward opening hardware solutions and locking systems

With its product range for outward opening hardware, Roto Frank offers solutions for a wide range of opening types in accordance with requirements. The large variety of locking systems makes it possible to meet individual security requirements and put together the system of your choice – regardless of whether the frame material consists of aluminium, timber or PVC.

1.2.1 Opening types

Side-Hung hinges

The sash is installed at the side and rotates around a fixed vertical axis when opened.



Top-Hung hinges

The sash is installed at the top and rotates around a fixed horizontal axis when opened.



Side-Hung

The sash is installed at the top and bottom and rotates around a vertical axis when opened. In this process, the entire sash moves slightly towards the middle of the window.

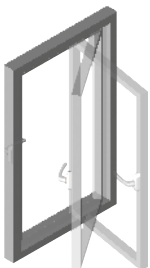

Top-Hung

The sash is installed at the side and rotates around a horizontal axis when opened. In this process, the entire sash moves slightly towards the middle of the window.



Top-Swing

The sash is installed at the side and pivots in the middle around a horizontal, movable axis when opened. In this process, the sash can be turned around completely.

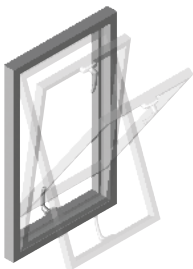

Parallel opening

The sash is installed at the side and extends parallel to the plane of the window when opened.





1.2.2 Scissor stay systems



Roto FS Kempton

Outward opening windows with friction stays have significant advantages. Firstly, the usable area in the room is retained in its entirety when the window is open. Secondly, outward opening windows such as Top-Hung or Side-Hung windows have extremely airtight and leakproof sashes, even when high wind loads impact the window.



Roto PS Aintree

Outward opening windows with parallel friction stays enable optimum ventilation due to the all-round opening. In addition, the usable area in the room is retained in its entirety when the window is open. Outward opening windows such as parallel projecting windows have extremely airtight and leakproof sashes, even when high wind loads impact the window.



Roto FRH Uni

On outward opening windows with fully reversible hinges, the sash can be turned around completely. This enables simple and safe cleaning from the inside. The sash can also be latched in a number of ventilation positions

1.2.3 Locking systems



Roto SSL

The SSL basic locking is specially designed for use in Top-Hung and Side-Hung windows. Mushroom cams in conjunction with adapted strikers ensure basic security. The night ventilation optionally integrated into the striker ensures additional ventilation comfort.



Roto TSL

The TSL security locking for Top-Hung and Side-Hung windows ensures a high level of security due to the reverse-action mushroom cams in conjunction with security strikers. These components make it much more difficult to jemmy or turn the sash. The night ventilation integrated into the striker ensures additional ventilation comfort.



Roto TSH

The TSH security locking can significantly increase sealing, operating convenience and security. The high level of flexibility and varied locking options, such as mushroom cams, locking hooks or shootbolts, leave nothing to be desired. The handle locking point integrated into the gearbox case and the optional Turn Plus night ventilation function are setting benchmarks.



Roto AL central locking system

The Roto AL central locking system reliably locks Top-Hung, Side-Hung and parallel projecting windows. The freely positionable centre locks ensure reliable gasket compression right up to the hinge side. A flush-encased gearbox or geared-handle can be used depending on requirements.



1.2.4 Profile sections

1.2.4.1 PVC

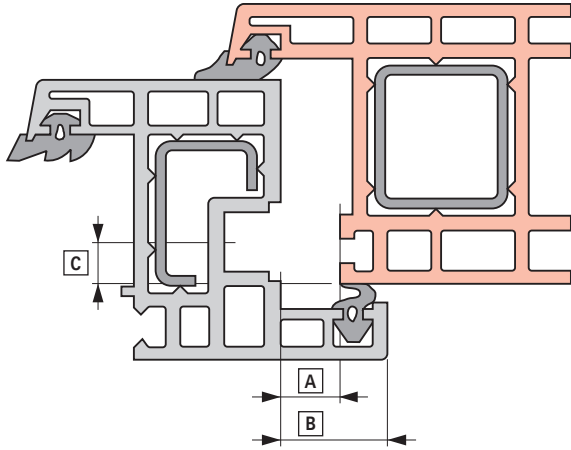

System	Rebate clearance [A]	Overlap width [B]	Hardware axis [C]
12/18-9	12 mm	18 mm	9 mm
12/18-13			13 mm
12/20-9		20 mm	9 mm
12/20-13			13 mm
12/21-13			21 mm
12/22-13			22 mm

1.2.4.2 Timber

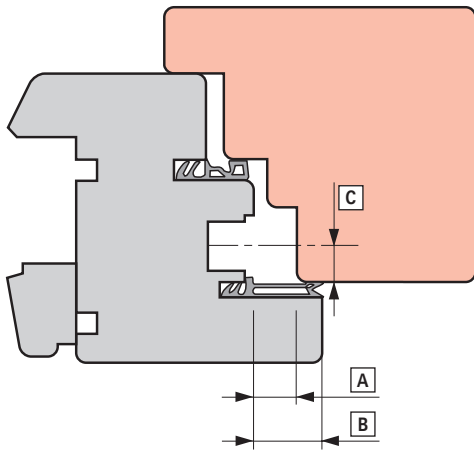

System	Rebate clearance [A]	Overlap width [B]	Hardware axis [C]	
12/18-9	12 mm	18 mm	9 mm	
12/18-13			13 mm	
12/20-9		20 mm	9 mm	
12/20-13			13 mm	
Euro-rebate 18			-	9 mm
Euro-rebate 20			-	9 mm
Euro-rebate 24		-	13 mm	
Euro-rebate 30		-	13 mm	
Euro-groove 7/8		-	9 mm	
Euro-groove 11/8		-	13 mm	

1.2.4.3 Aluminium

Profile versions

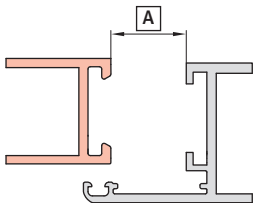

Frame with groove
 Sash with groove

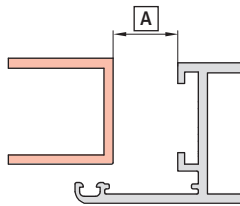

Frame without groove
 Sash with groove

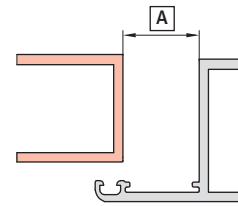

Frame without groove
 Sash without groove

Friction stay	Rebate clearance [A]
HX	16 - 17
LB...-F	13 - 14
LB...-S16	16 - 17
LM	13 - 14

Groove versions

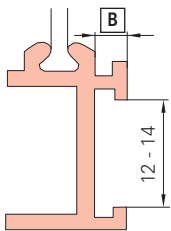

Groove version V.01

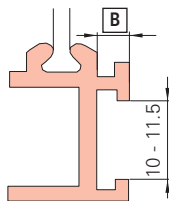

Groove version V.02

Groove version	FgD = frame groove insertion depth [B]
V.01	4.5 - 5
V.02	4.5 - 5



INFO

When ordering profile-related frame components, the groove versions must be noted.



1.3 Storage conditions

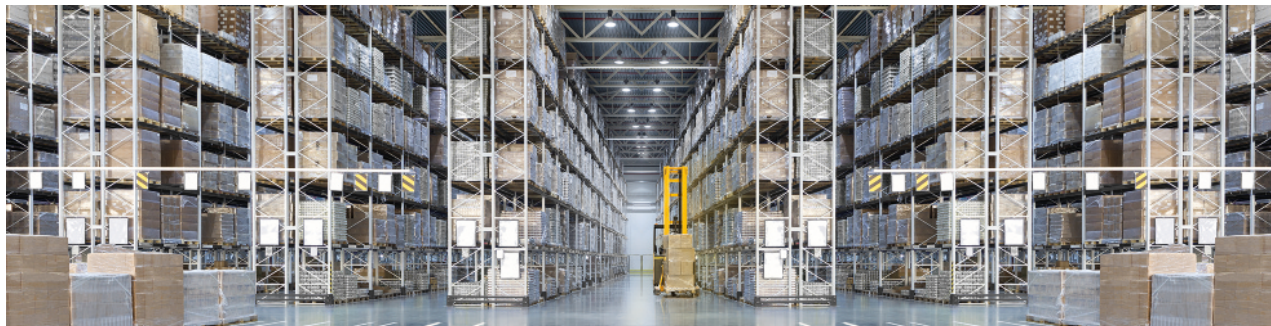

Protecting components against dirt and dust

Always keep the containers closed, and always cover open hardware containers or goods stored open (i.e. with a layer of cardboard).

Protecting components against mechanical damage

Only transport and handle the containers using suitable means of transport or conveyance (forklifts, lifting devices and roller belts, etc.). Only stack pallets and cardboard boxes (during transport) to the maximum height specified in the printed instructions on the packaging.

Protecting components against direct moisture and wet

The packaging must remain dry and the components must not get wet. This applies to storage and transport, as well as for unloading and loading procedures. Where appropriate, plastic protective sheets or similar are to be used during outdoor transport (i.e. on-site transport) when raining.

Only store components in suitable closed rooms and not outdoors. Condensation must absolutely be avoided during the entire duration of transport and storage.

If containers nevertheless get wet...

Immediately unpack the components from the wet containers, dry the components and check for damage (signs of corrosion). In any case, repack the usable components when dry with new packaging material

1.4 Environment



Environmental compatibility of the hardware components

Our objective is to succeed in manufacturing our hardware components with the lowest possible consumption of energy and operating resources, and we strive to produce extremely durable hardware components. To achieve this, we conserve natural resources, minimise energy consumption and use raw materials in an environmentally friendly manner.

Environmental impact resulting from the hardware

The surface quality of our treated surfaces is abrasion-resistant. No environmental pollution is caused by hardware components when the stipulated use is complied with.

Environmental compatibility of the packaging

We use recyclable disposable packaging made of reinforced cardboard, steel strapping, PVC packaging tape, PE sheeting, timber frames, single-use wooden pallets, cable ties, elastomer cord as well as reusable packaging, reusable boxes from Schäfer, pallet crates and EURO wooden pallets.

Environmental compatibility of disposal

Our hardware is made of materials which enable environmentally friendly material utilisation and can be disposed of as mixed scrap.

Returning packaging material

Our packaging with the INTERSEROH logo is accepted free of charge by every INTERSEROH disposal partner. The directory of your local disposal partners can be requested nationwide from the telephone exchange of ISD INTERSEROH GmbH in Cologne using the following telephone number: +49 2203 9147-322. The Roto INTERSEROH number is 25582.



1.5 Gütegemeinschaft Schlösser und Beschläge e.V.

Everything you need to know about the correct use and maintenance of hardware for windows and balcony doors can be found in the current directives issued by Gütegemeinschaft Schlösser und Beschläge e.V.

Gütegemeinschaft Schlösser und Beschläge e.V.	
ORIGINALFASSUNG Ausgabe 2020-11-12	
Richtlinie	
Beschläge für Fenster und Fenstertüren	
Vorgehen bei einem Produktmangel (VHB 1) (VHB 1)	
Inhalt	
1. Anwendungsbereich dieser Richtlinie	4
2. Symboleklärung	5
3. Die Gruppenbeschreibung	10
4. Allgemeine Funktionen und Anwendungsbereiche der Beschläge	15
5. Haltungsverhalten	22
6. Sicherheit	23
7. Wartung/Pflege und Inspektion	24
Hinweise:	
Gütegemeinschaft Schlösser und Beschläge e.V. 42699 Köln, 10 02201 20000 E-Mail: info@rotolock.de Web: www.rotolock.de	
Hinweise	
Technische Änderungen vorbehalten Diese Richtlinie ist kein Ersatz für die Bedienungsanleitung	
1008-1-10-1	1-20

VHBH

Hardware for windows and balcony doors –
 Guidelines/advice on the product and on
 liability

Gütegemeinschaft Schlösser und Beschläge e.V.	
ORIGINALFASSUNG Ausgabe 2020-11-12	
Richtlinie	
Beschläge für Fenster und Fenstertüren	
Vorgehen bei einem Produktmangel (VHB 1) (VHB 1)	
Inhalt	
1. Anwendungsbereich dieser Richtlinie	4
2. Symboleklärung	5
3. Die Gruppenbeschreibung	10
4. Allgemeine Funktionen und Anwendungsbereiche der Beschläge	15
5. Haltungsverhalten	22
6. Sicherheit	23
7. Wartung/Pflege und Inspektion	24
Hinweise:	
Gütegemeinschaft Schlösser und Beschläge e.V. 42699 Köln, 10 02201 20000 E-Mail: info@rotolock.de Web: www.rotolock.de	
Hinweise	
Technische Änderungen vorbehalten Diese Richtlinie ist kein Ersatz für die Bedienungsanleitung	
1008-1-10-1	1-20

VHBE

Hardware for windows and balcony doors –
 Guidelines/advice for end-users

Gütegemeinschaft Schlösser und Beschläge e.V.	
ORIGINALFASSUNG Ausgabe 2020-11-12	
Richtlinie	
Belegung tragender Beschläge für ein Dreh- und Dreh-&-Dreh-Baugewerk	
Vorgehen bei einem Produktmangel (VHB 1) (VHB 1)	
Inhalt	
1. Anwendungsbereich dieser Richtlinie	4
2. Symboleklärung	5
3. Die Gruppenbeschreibung	10
4. Allgemeine Funktionen und Anwendungsbereiche der Beschläge	15
5. Haltungsverhalten	22
6. Sicherheit	23
7. Wartung/Pflege und Inspektion	24
Hinweise:	
Gütegemeinschaft Schlösser und Beschläge e.V. 42699 Köln, 10 02201 20000 E-Mail: info@rotolock.de Web: www.rotolock.de	
Hinweise	
Technische Änderungen vorbehalten Diese Richtlinie ist kein Ersatz für die Bedienungsanleitung	
1008-1-10-1	1-20

TBDK

Attachment of supporting fitting components
 for turn-only and tilt&turn fittings with defini-
 tions for turn-only and tilt&turn fittings and their
 possible installation positions

1.6 Certifications

1.6.1 Quality management

The certification in accordance with the international standard DIN EN ISO 9001 certifies that Roto plans, documents and appropriately implements the entire development, production and sales process systematically. Starting with development and design through to quality planning, production and assembly right through to sales and customer service.

The certification is an external indication of the quality awareness practised at Roto:

- Roto's objective is to ensure continuous product and service improvements for the benefit of its customers.
- Roto offers its customers innovative, environmentally friendly and technically sophisticated architectural hardware technology.
- Roto products are supplied punctually worldwide with constant guaranteed quality.
- Roto's comprehensive view regards all business activities – including all the activities within the company – to be the key to achieving long-term corporate success.
- Roto employees are supported in their personal development and fulfil Roto's high quality requirements in their day-to-day work. Their work is performance and goal-oriented.



ZERTIFIKAT



Hiermit wird bescheinigt, dass



**Roto Frank Fenster- und
Türtechnologie GmbH**
Zentrale
Wilhelm-Frank-Platz 1
70771 Leinfelden-Echterdingen
Deutschland

mit den im Anhang gelisteten Standorten

ein **Qualitätsmanagementsystem** eingeführt hat und anwendet.

Geltungsbereich:
Entwicklung/Konstruktion, Herstellung und Vertrieb von Fenster- und Türtechnologie

Durch ein Audit, dokumentiert in einem Bericht, wurde der Nachweis erbracht,
dass das Managementsystem die Forderungen des folgenden Regelwerks erfüllt:

ISO 9001 : 2015

Zertifikat-Registrier-Nr.	059808 QM15	 
Revisionsdatum	2019-06-11	
Gültig ab	2018-05-18	
Gültig bis	2021-05-17	
Zertifizierungsdatum	2019-06-11	

DQS GmbH



Markus Bleher
Geschäftsführer

Akkreditierte Stelle: DQS GmbH, August-Schanz-Straße 21, 60433 Frankfurt am Main

1 / 3



1.6.2 International Technology Centre (ITC)

Roto has owned a modern International Technology Centre (ITC) at its Leinfelden headquarters since October 1996. This facility is available for both our own material and product testing as well as for inspecting finished products made by Roto market partners.

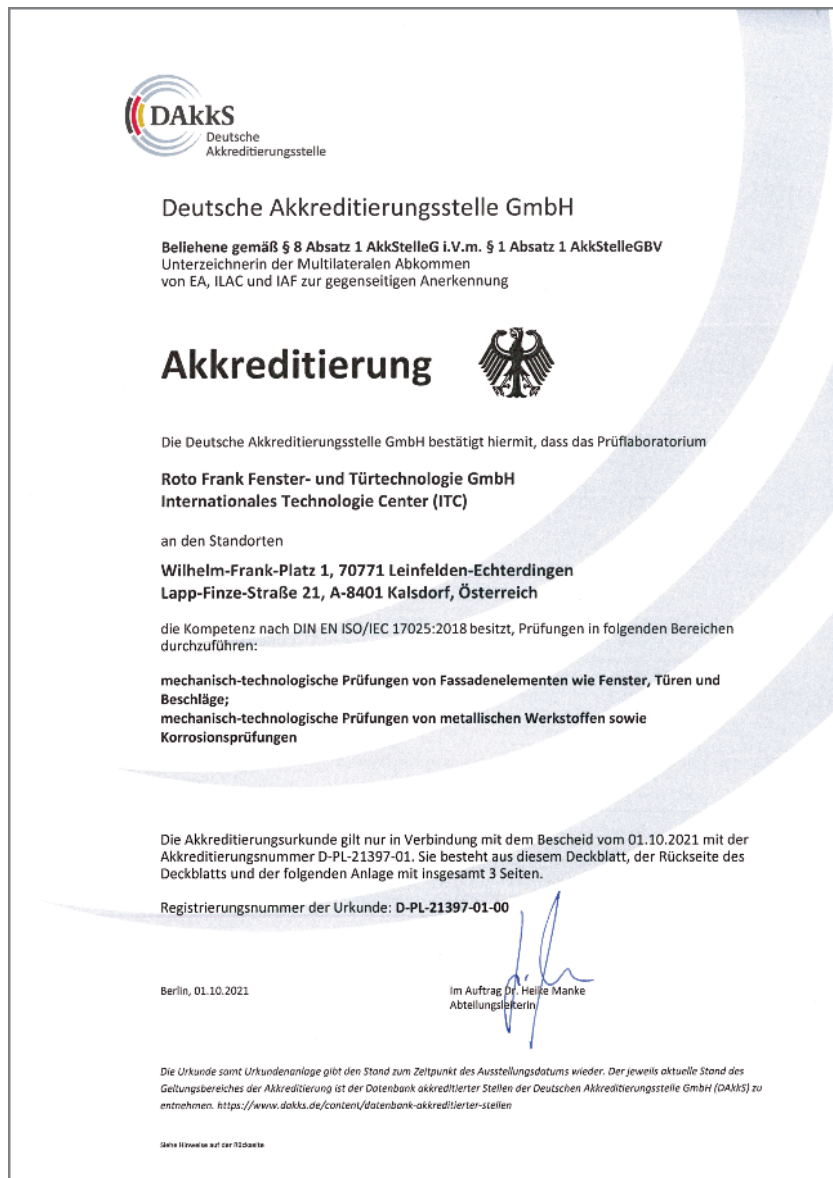

The ITC is accredited in accordance with DIN EN ISO / IEC 17025 and has the expertise required to perform tests in areas including mechanical technological testing of facade elements such as windows, doors and hardware, as well as metallic materials.

Achieving accreditation in accordance with DIN EN ISO / IEC 17025 represents the highest distinction for a test institute in the private sector. The requirements for this are an extensive quality management system, trained personnel, high-quality test rigs and measuring instruments, as well as continuous external monitoring by the accreditation authorities.

1.7 Roto Con Orders

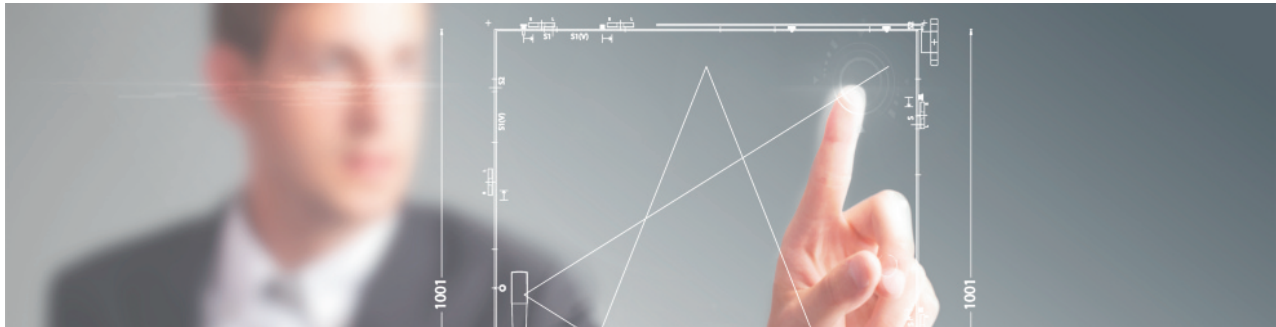

Just four steps for a finished parts list

Roto Con Orders is the perfect solution for window and door manufacturers, and for dealers. This is because with the high-performance online hardware configurator, an individual configuration of window and door hardware can be generated very easily and in an extremely short time – for all common shapes and opening types. Just a few mouse clicks and a couple of numeric entries, and the individual parts list including a technical illustration of the hardware itemising is finished. The list can be changed, adapted or personalised as desired. It can be exported in various data formats, enabling it to be used for individual offers or orders. Benefit from this efficient Roto online tool, save time during configuration, management and ordering – with Roto Con Orders.

Hardware configuration has never been this easy

With intuitive menu guidance, you generate an optimum parts list in just four steps:

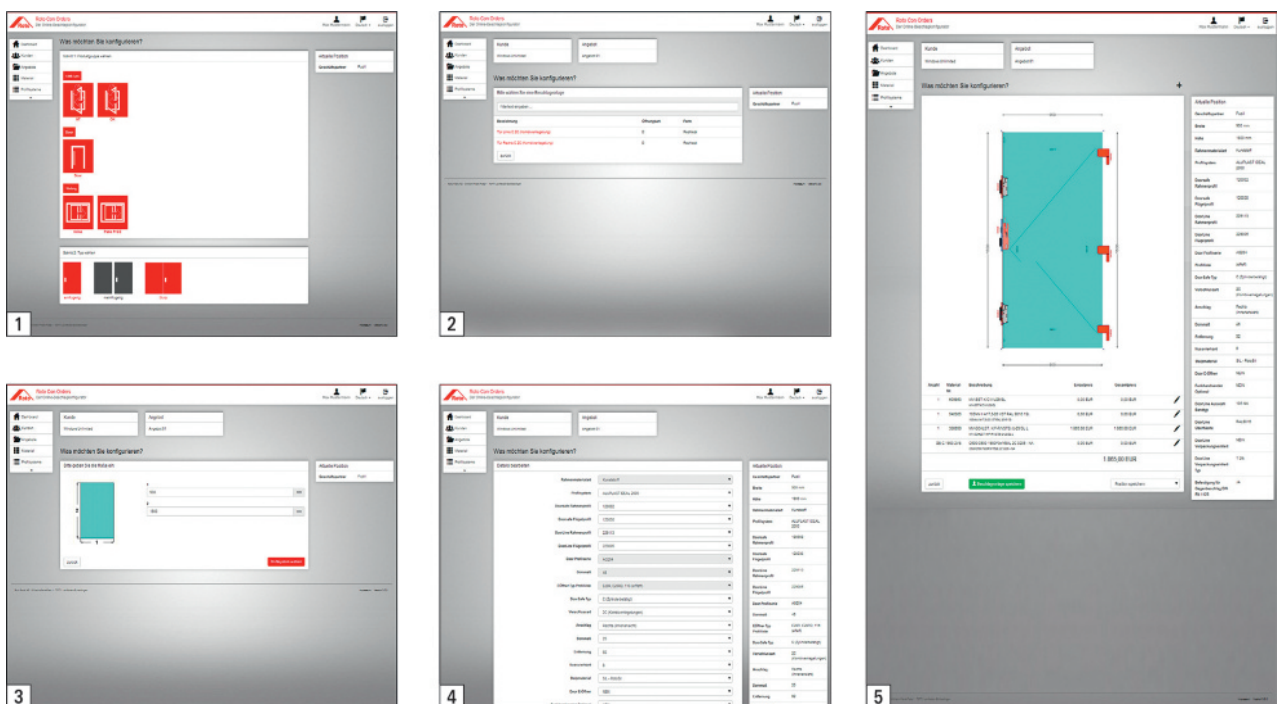

1. Selection of the product group
2. Selection of the design template
3. Entry of sizes
4. Individual detailed settings and adaptations
5. **Result:** output of a detailed data sheet with a technical illustration and a complete parts list with editable order numbers, descriptions and individual and total prices.



Intelligent additional functions simplify your processes



Roto Con Orders makes it easy for you to simplify and accelerate your processes. A large number of useful functions are available to help you do this:

- Store your own company addresses and logos in the header of your offers
- Create and manage customer-specific projects
- Generate individual customer hardware templates
- Integrate a discount structure system
- Material master management
- Due to its responsive design, it can be used on all devices such as PCs, tablets, and smartphones

Get started straight away thanks to web-based solution

Roto Con Orders is a web-based solution that you can access around the world and around the clock. You only require a computer with a web browser and Internet access for this purpose. To work with the online hardware configurator, please register once with your e-mail address in the portal for dealers and manufacturers at:



www.roto-frank.com



1.8 Roto media portal

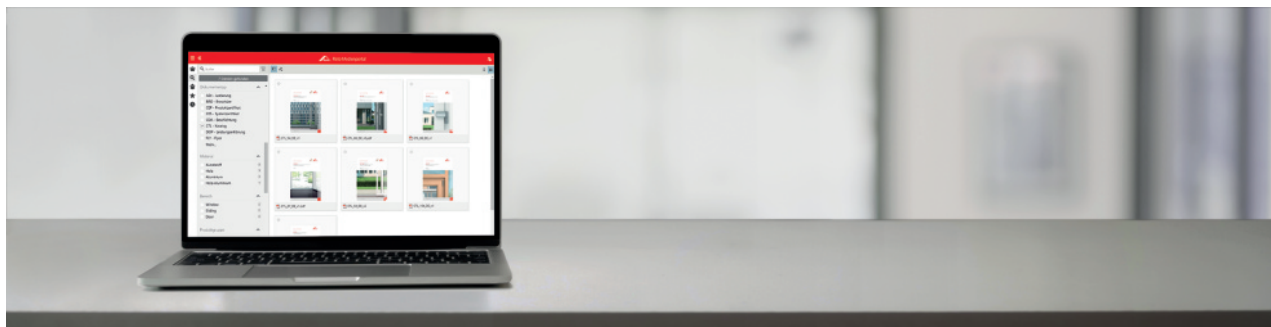

Simple and quick

The Roto media portal is where all media is available, such as catalogues, installation instructions, brochures and interactive installation videos. Access to this portal is optimised for PCs, laptops and mobile devices.

The clear user interface and the numerous search options ensure that all available media can be found simply and quickly. Content can be read directly in the Roto media portal or downloaded for later.

The Roto media portal can be accessed via the “Downloads” link in the “Service” main menu item on the Roto website or directly using the links below.



www.roto-frank.com

Media for Roto Outward Opening

This catalogue offers an overview of the Roto Outward Opening product range. All other media relating to Roto Outward Opening can be accessed via the Roto media portal. The links below provide direct access.



www.roto-frank.com | Roto Outward Opening



1.9 Further Roto products

1.9.1 Roto Window

Tilt&Turn – Tilt&Turn hardware systems for windows and balcony doors

Timber and PVC



Roto NX

The Tilt&Turn hardware system for windows and balcony doors shaping the industry once again



Roto NT

The world's biggest selling Tilt&Turn hardware system for windows and balcony doors

Aluminium



Roto AL

Universal hardware for aluminium windows and balcony doors



Roto AL Designo

Concealed hardware for aesthetic aluminium windows and balcony doors

Outward Opening – Hardware systems for outward opening windows



Roto FS Kempton

Stainless-steel friction stays for outward opening windows



Roto PS Aintree

Parallel stainless-steel friction stays for outward opening windows



Roto FRH Uni

Fully reversible hinges for outward opening windows

1.9.2 Roto Sliding

Roto Patio – High-quality sliding windows and doors



Roto Patio Fold

Premium hardware for Fold&Slide systems with a large surface



Roto Patio Life

Comfort hardware for large sliding doors



Roto Patio Lift

Hardware for versatile use in Lift&Slide systems



Roto Patio Alversa

Universal hardware for minimum effort in Parallel Sliding and Tilt&Slide systems



Roto Patio Inowa

Intelligent hardware for tightly sealed sliding systems

Roto Inline – Basic sliding windows and doors



Roto Inline

The hardware system for basic sliding windows and sliding doors



1.9.3 Roto Door

Roto Safe – The modular multipoint locking system for doors



Roto Safe H

Mechanical multipoint lockings for lever-handle-operated doors



Roto Safe C

Mechanical multipoint lockings for cylinder-operated doors



Roto Safe E

Electromechanical multipoint lockings for doors



Roto Safe P

Mechanical multipoint lockings for escape and panic doors

Roto Solid – Comprehensive range of door hinges



Roto Solid S

Screw-on hinges for doors



Roto Solid B

Butt hinges for doors



Roto Solid C

Concealed hinges for doors

Roto Eifel – Thresholds for doors and balcony doors



Roto Eifel

Tailor-made range of thresholds for tightly sealed accessible doors and balcony doors

1.9.4 Roto Equipment

Drive&Control – Electronic components for windows and doors



Roto E-Tec Drive
The concealed drive for windows



Roto E-Tec Control
Wired sensors for security technology and room climate



Roto Com-Tec Sensor
Wireless sensors integrated in hardware for home security

Handles – Handles for all opening types



Roto Swing
The modern handle line



Roto Line
The classic handle line



Roto Samba
The classic yet modern handle line



Roto Freestyle
Solutions for all opening types

Fix&Glazing – Installation and glazing solutions for windows and doors



Roto Glas-Tec
Customised solutions for safe glazing



1.10 Contact

Roto Frank

Fenster- und Türtechnologie GmbH

Wilhelm-Frank-Platz 1

70771 Leinfelden-Echterdingen

Germany

Phone +49 711 7598 0

Fax +49 711 7598 253

info@roto-frank.com

www.roto-frank.com

Roto FS Kempton

General hardware characteristics	34
Product finder	37
Application diagrams	37
Hardware overviews	48
Friction stays	52
Turn-Only hinge	57
Accessories	58

Roto PS Aintree

General hardware characteristics	67
Application diagrams	70
Hardware overviews	72
Parallel projecting scissor stays	75
Accessories	76

Roto FRH Uni

General hardware characteristics	78
Application diagrams	79
Hardware overviews	80
Fully reversible hinges	81
Sash bearing	83
Topglider	84
Accessories	85

2 Stay systems

2.1 Roto FS Kempton

2.1.1 General hardware characteristics

2.1.1.1 Friction stays

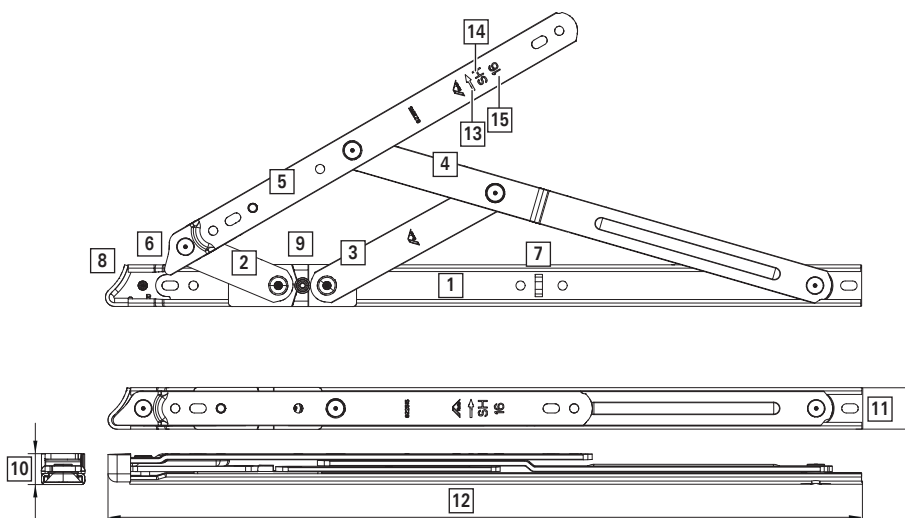

- | | | | |
|-----------------|--------------------------|---------------------------------------|------------------------|
| [1] Guide track | [5] Scissor stay arm | [9] Brake | [13] Opening direction |
| [2] First link | [6] Scissor stay arm lug | [10] Scissor stay installation height | [14] Opening type |
| [3] Second link | [7] End stop | [11] Scissor stay width | [15] Scissor stay size |
| [4] Third link | [8] Retraction mechanism | [12] Scissor stay length | |

Technical features

- Side-Hung and Top-Hung version of friction stays.
- Adjustable friction stays.
- Can be used for a variety of sash formats.
- Sash weights up to max. 180 kg with scissor stay size of 26".
- Surface: class 5 = 480 h corrosion resistance (EN 1670:2007).
- Resistance to repeated opening and closing: class H3 = 20,000 cycles DIN EN 13126-6:2018 or 35,000 cycles JG/T 127:2017.
- Safety in use class 1.

Advantages

- Specified mounting points enable correct installation simply and quickly.
- Tight sealing in outward opening windows.
- High-performance components are used in the entire scissor stay area. This achieves high operational reliability.

Benefits

- Simple, reliable operation.
- Ten-year performance warranty.
- Entire room can be used because the window opens outward.



2.1.1.2 Opening restrictor

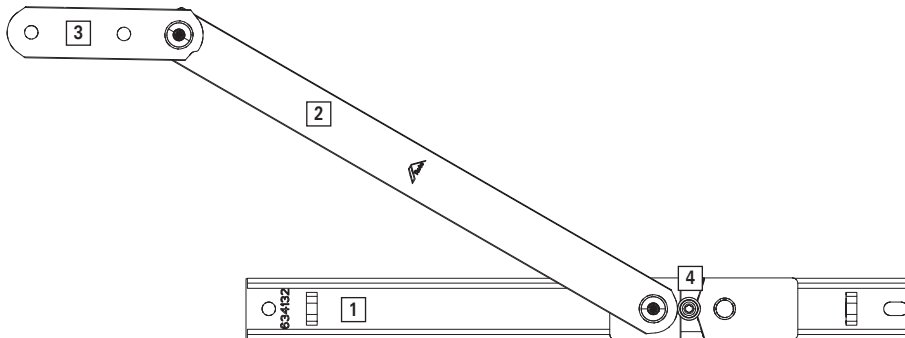

- [1] Guide track
- [2] Arm
- [3] Sash bearing
- [4] Brake

Purpose of use

- To help prevent the window moving by itself or to limit the opening width.

Operation

In daily use, the sash with the RH version of the Roto FS Kempton opening restrictor is opened until the slider hits the end point.



INFO

Choose a sash opening width that will not cause self-jamming of the sash.

2.1.1.3 Processing instructions

Friction stay

Positioning and rebate clearance

- The Roto FS Kempton friction stays are designed to be installed between two parallel, fixed surfaces with a correct rebate clearance distance.
- The retraction mechanism of the friction stays must be placed in the inner corner of the frame rebate unless adaptation is required.
The friction stays are positioned in the inner corners of the frame.
- If the profile does not have any parallel surfaces for mounting the scissor stays, use packer strips or adapters to fill the gap and adapt the scissor stay space in accordance with requirements .
- The installation space for the friction stays must meet the requirements defined in this document.

Sash formats

- Refer to the specifications of the friction stays for the maximum permitted sash heights and widths.
- Do not exceed the maximum permitted sash weight → 2.1.3 "Application diagrams" from page 37.
The component with the lowest permitted load bearing capacity determines the maximum permitted sash weight.
- Before using electronic data records and implementing them in window fabrication programs in particular, check that they match the specifications, application diagrams and component assignments.

Limiting the opening width

- Additional hardware components (such as opening restrictors) may be required to hold sashes in a specific position.

This applies particularly to large formats, very small opening angles (10° or less) or in areas exposed to wind.

- Windows with Top-Hung friction stays of sizes 10" to 26" are equipped with an internal opening width restrictor. An additional opening restrictor can be installed if necessary → 2.1.3 "Application diagrams" from page 37.
- Installation or maintenance work may require opening angles that exceed the nominally permitted opening angles of the friction stays. These opening angles must not be used in regular operation. For this reason, take suitable measures (such as integrated opening restrictor or additional opening restrictor) to limit the sashes to the maximum permitted opening angle.

Specifications from profile manufacturers

- The window and balcony door manufacturer must comply with all specified system dimensions (e.g. gasket gap dimensions or locking distances).
- They must continue to ensure and check this on a regular basis, especially when new hardware components are used for the first time, during production and on a continuous basis, up to and including window installation.



INFO

The hardware components are always designed in such a way that any system dimensions affected by the hardware can be adjusted. The hardware manufacturer shall not be liable for any additional expenses incurred if a deviation from these dimensions is not discovered until after the windows have been installed.

Combining hardware

- Windows and balcony doors for wet rooms and those for use in environments with aggressive, corrosive constituents in the air require hardware that meets special requirements.
- The resistance of windows and balcony doors to wind loads when they are closed and locked depends on the individual design of the windows and balcony doors. The hardware system is capable of handling wind loads specified by legislation and standards (for example in accordance with EN 12210 – especially test pressure P3).
- Coordinate suitable hardware combinations and installation procedures in windows and balcony doors with the hardware manufacturer and profile manufacturer for the areas listed above, and conclude a separate agreement for them.



INFO

The hardware manufacturer's specifications on the combination of hardware (e.g. the use of additional scissor stays, the design of hardware for burglar-inhibiting window sashes and balcony door sashes) are binding.

Opening restrictor

Positioning and rebate clearance

- All Roto FS Kempton opening restrictors are designed to be installed between two parallel, fixed surfaces whose dimensions correspond to the specifications in this document.
- The scissor stay space between the sash and outer frame or upstand must meet the requirements for opening restrictors defined in this document (see drawings) → from page 58.



- The closer the opening restrictor and the friction stay are to one another, the larger the sash opening angle; accordingly, installing the opening restrictor further away from the friction stay reduces the opening angle.

Using the opening restrictor

Depending on the rigidity of the window sash, one opening restrictor at the bottom or two opening restrictors (at the top and bottom) may be used for Side-Hung sashes. For Top-Hung sashes, two opening restrictors must always be used as required.



INFO

The opening width depends on:

- the positioning of the opening restrictor,
- the friction stay used,
- the sash size,
- the window profile.

- The window profile must match the requirements of the opening restrictor.
- The opening restrictors must be fitted on both sides (Top-Hung) or at the top and bottom (Side-Hung).



INFO

If there is insufficient space available for installing opening restrictors and friction stays, Roto provides assistance with the generally recommended profile assessments.

2.1.2 Product finder

Opening type	Groove width	Rebate depth	Friction stay	
Top-Hung	18.5	13.5 ±0.5	LB	→ from page 54
		16.5 ±0.5	LB	
	23 +0.5	16.5	HX	→ from page 52
Side-Hung	18.5	13.5 ±0.5	LB	→ from page 54
			LM	→ from page 56
	23 +0.5	16.5 ±0.5	LB	→ from page 54
			HX	→ from page 52

2.1.3 Application diagrams

2.1.3.1 Application ranges

FS Kempton	
HX	Heavy-duty friction stays for industrial purposes in the extended application range.
LB	Lightweight friction stays for private purposes in the standard application range.
LM	Lightweight Side-Hung friction stays with simple cleaning function.



INFO

The LM hinge side offers additional functions (e.g. "easy cleaning").

2.1.3.2 HX

2.1.3.2.1 Top-Hung



INFO

The middle of the application range is where the operating forces when opening and closing are the most balanced.

The exception is HX TH 26": with this version, the operating forces are the most balanced at the upper end of the application range.





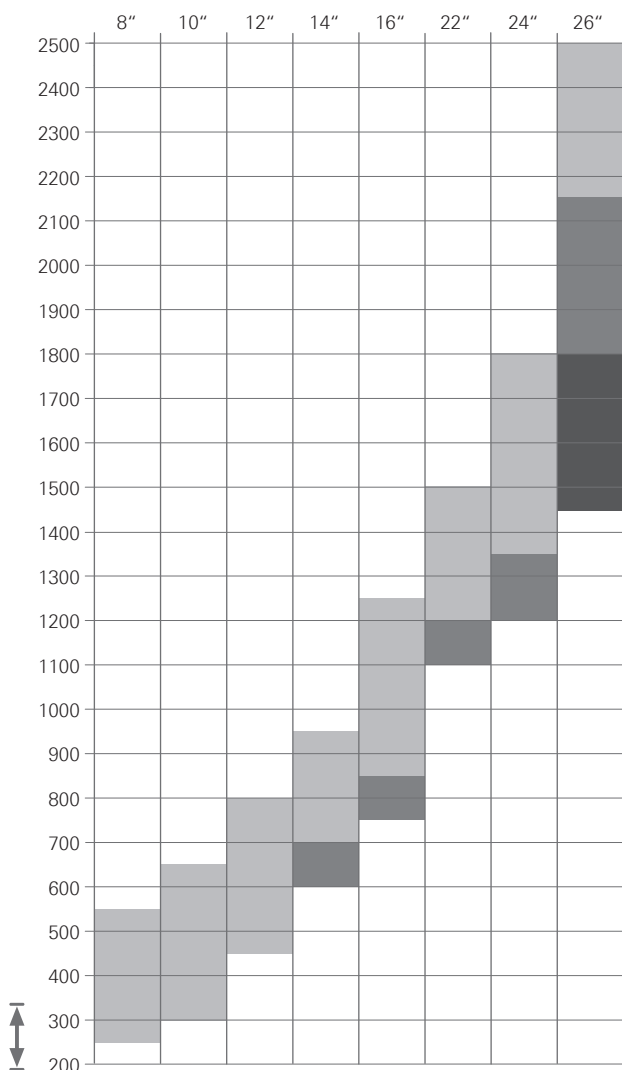

INFO

If manually operated sashes go beyond the specified application range, contact the technical customer service team.

Top-Hung





-  = Impermissible application range
-  = Application range
-  = Use of an opening restrictor (opening width 100 mm)
-  = Use of an opening restrictor (opening width 300 mm)



INFO

Select the scissor stay size so that the SRH is in the middle of the application range.

Application ranges

Friction stay	Sash rebate height	Sash weight	Opening angle	Opening width
HX SH / TH 08	300 – 450	35 kg	max. 50° ^[1]	
HX TH 10	300 – 650	35 kg	max. 40°	
HX TH 12	450 – 800	45 kg	max. 40° ^[2]	max. 500 mm ^[3]
HX TH 14	600 – 950	50 kg	max. 40°	
HX TH 16	750 – 1250	65 kg	max. 50° ^[2]	
HX TH 22	1100 – 1500	100 kg	max. 20° ^[1]	max. 500 mm ^[3]
HX TH 24	1200 – 1800	120 kg	max. 20° ^[1]	max. 500 mm ^[3]
HX TH 26	1450 – 2500	180 kg	max. 20° ^[1]	max. 500 mm ^[3]

[1] Depending on the profile system, only a limited installation sequence may be possible and the brake might not be adjustable.

[2] Depending on the format and weight, it may be necessary to use an opening restrictor as an additional brake.

[3] The opening width may need to be limited to reduce the operating forces.



INFO

Depending on the maximum permitted sash weight, the sash width can be unlimited.

2.1.3.2.2 Side-Hung



INFO

If manually operated sashes go beyond the specified application range, contact the technical customer service team.



INFO

Lower deductible dimensions of glass or higher profile weights require a separate assessment.



INFO

Depending on the maximum permitted sash weight, the sash height can be unlimited.

HX SH / TH 08

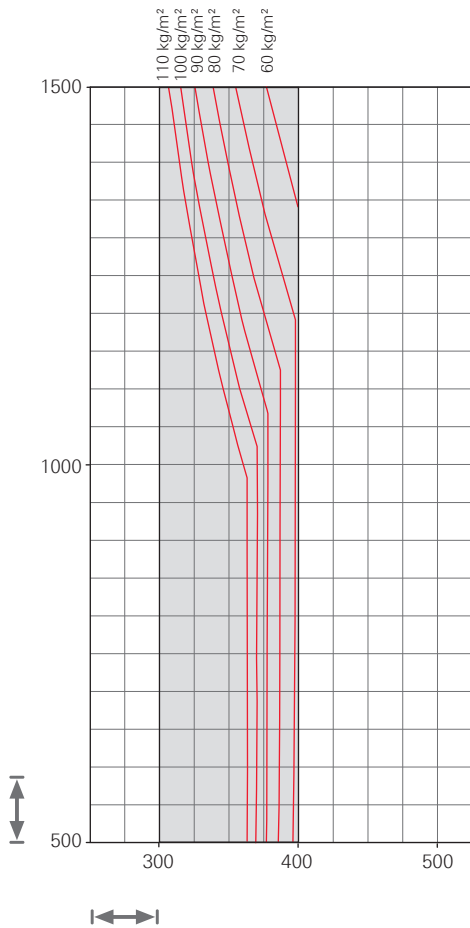

= Impermissible application range





The specifications in the application diagram refer to the glass weight in kg/m².

1 mm/m² glass thickness \approx 2.5 kg

Assumption: sash profile weight is 2 kg/m.



Application range

Basic security		
	Sash rebate width	300 – 400 mm
	Sash rebate height	Depending on the maximum permitted sash weight, the sash height can be unlimited.
	Sash weight	35 kg
	Opening angle	max. 50°



HX SH 10

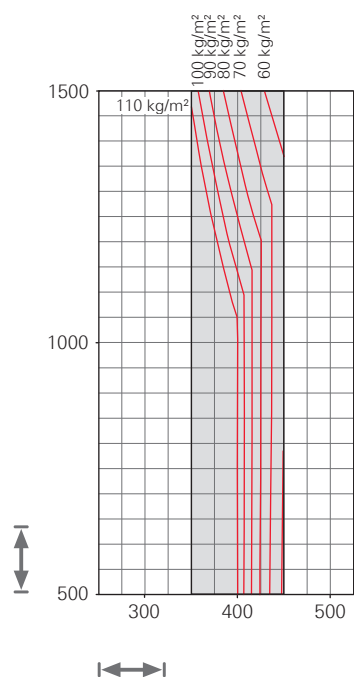



 = Impermissible application range

The specifications in the application diagram refer to the glass weight in kg/m².

1 mm/m² glass thickness \approx 2.5 kg

Assumption: sash profile weight is 2 kg/m.

Application range

Basic security		
	Sash rebate width	350 – 450 mm
	Sash rebate height	Depending on the maximum permitted sash weight, the sash height can be unlimited.
	Sash weight	40 kg



Basic security		
	Opening angle	max. 87°

HX SH 12

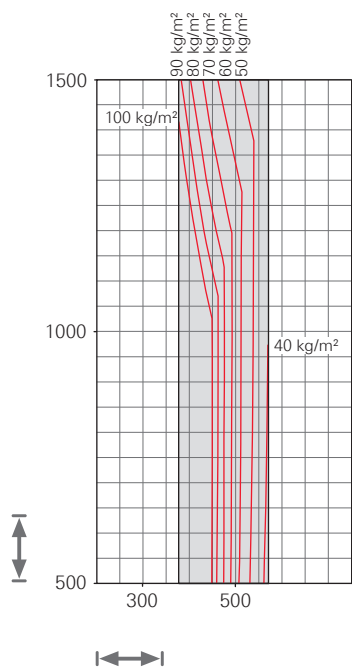





 = Impermissible application range

The specifications in the application diagram refer to the glass weight in kg/m².

1 mm/m² glass thickness \approx 2.5 kg

Assumption: sash profile weight is 2 kg/m.

Application range

Basic security		
	Sash rebate width	380 – 570 mm
	Sash rebate height	Depending on the maximum permitted sash weight, the sash height can be unlimited.
	Sash weight	40 kg
	Opening angle	max. 87°



HX SH 14

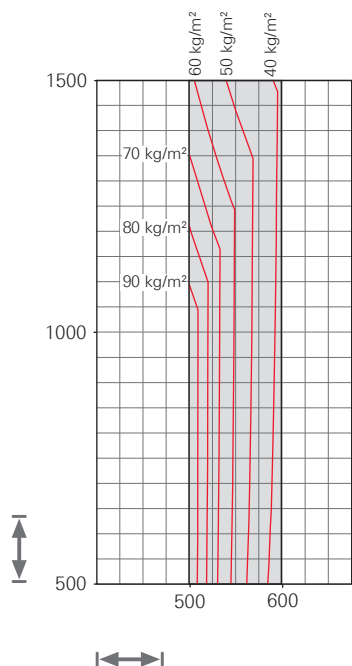

= Impermissible application range



The specifications in the application diagram refer to the glass weight in kg/m².

1 mm/m² glass thickness \approx 2.5 kg

Assumption: sash profile weight is 2 kg/m.

Application range

Basic security		
	Sash rebate width	500 – 600 mm
	Sash rebate height	Depending on the maximum permitted sash weight, the sash height can be unlimited.
	Sash weight	40 kg
	Opening angle	max. 87°

HX SH 16

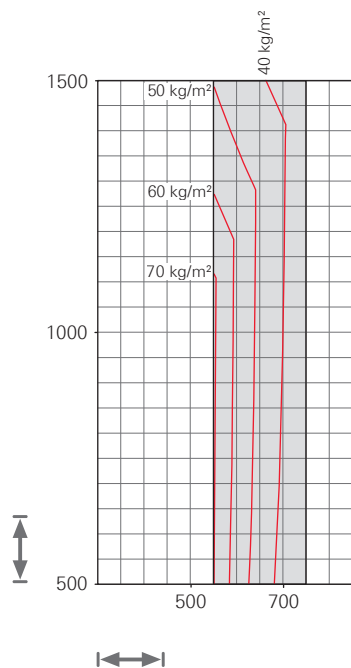

= Impermissible application range

The specifications in the application diagram refer to the glass weight in kg/m².

1 mm/m² glass thickness \approx 2.5 kg

Assumption: sash profile weight is 2 kg/m.

Application range

Basic security		
	Sash rebate width	550 – 750 mm
	Sash rebate height	Depending on the maximum permitted sash weight, the sash height can be unlimited.
	Sash weight	45 kg
	Opening angle	max. 87°



2.1.3.3 LB

2.1.3.3.1 Top-Hung

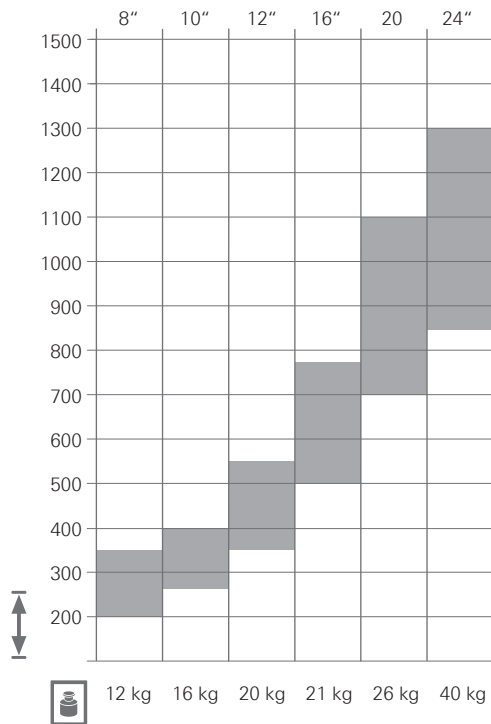

= Impermissible application range
 = Application range

Application ranges

Friction stay	Sash rebate height	Sash weight
LB TH 08	200 – 350	12 kg
LB TH 10	275 – 400	16 kg
LB TH 12	350 – 550	20 kg
LB TH 16	500 – 780	21 kg
LB TH 20	700 – 1100	26 kg
LB TH 24	850 – 1300	40 kg



INFO

Depending on the maximum permitted sash weight, the sash width can be unlimited.

2.1.3.3.2 Side-Hung

LB SH 12

S.kg max. 22 kg

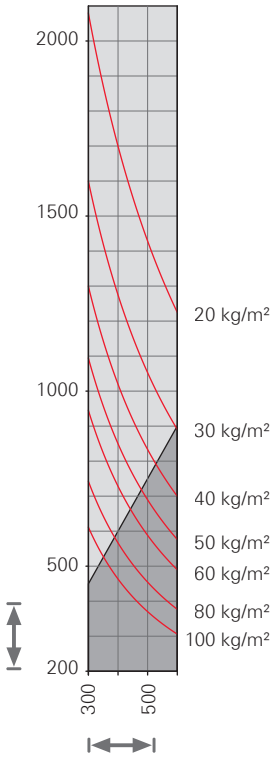

LB SH 16

S.kg max. 24 kg

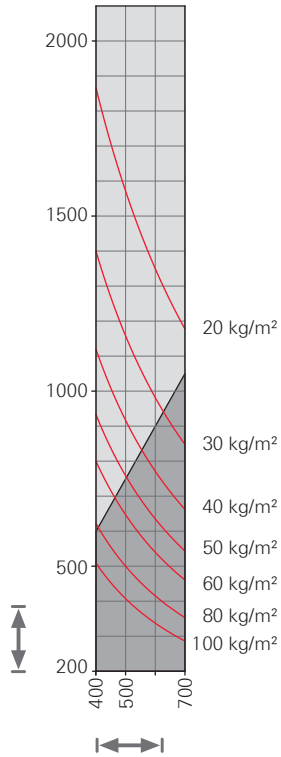



 = The height of Side-Hung sashes must be at least 1.5 times the sash width.

 = On Side-Hung sashes with a height that is less than 1.5 times their width, regular readjustment may be required to align the sash in the frame.

The specifications in the application diagram refer to the glass weight in kg/m².

1 mm/m² glass thickness ≈ 2.5 kg

Assumption: sash profile weight is 2 kg/m.

Application range		
	Sash width	300 – 700 mm
	Sash height	300 – 2100 mm
	Sash weight	max. 24 kg



INFO

The stated sizes refer only to the load-bearing capacity of the friction stays. Profile limitations due to window formats are not taken into consideration in this illustration and must be checked separately by the window manufacturer.



2.1.3.4 LM

2.1.3.4.1 Side-Hung

LM SH 12

S.kg max. 22 kg

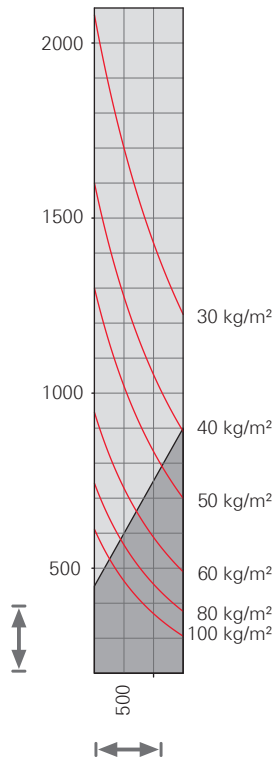

LM SH 16

S.kg max. 24 kg

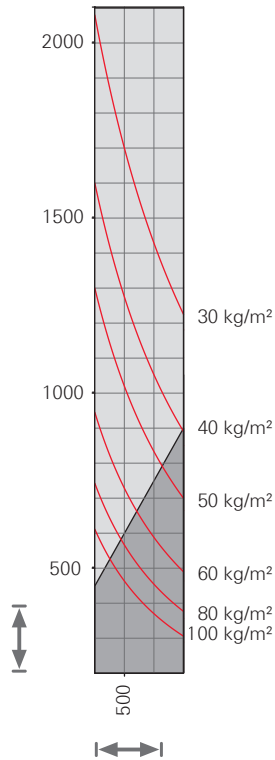

= The height of Side-Hung sashes must be at least 1.5 times the sash width.
 = On Side-Hung sashes with a height that is less than 1.5 times their width, regular readjustment may be required to align the sash in the frame.

The specifications in the application diagram refer to the glass weight in kg/m².

1 mm/m² glass thickness ≈ 2.5 kg

Assumption: sash profile weight is 2 kg/m.

Application range		
	Sash width	300 – 700 mm
	Sash height	200 – 2100 mm
	Sash weight	max. 24 kg



INFO

The stated sizes refer only to the load-bearing capacity of the friction stays. Profile limitations due to window formats are not taken into consideration in this illustration and must be checked separately by the window manufacturer.

2.1.4 Hardware overviews



INFO

All hardware overviews shown in this chapter are for illustration purposes only. Please refer to the applicable installation instructions for exact specifications and installation advice.

2.1.4.1 Product finder

Opening type	Groove width	Rebate depth	Friction stay	
Top-Hung	18.5	13.5 ±0.5	LB	→ from page 54
		16.5 ±0.5	LB	
	23 +0.5	16.5	HX	→ from page 52
Side-Hung	18.5	13.5 ±0.5	LB	→ from page 54
			LM	→ from page 56
		16.5 ±0.5	LB	→ from page 54
	23 +0.5	16.5	HX	→ from page 52



2.1.4.2 FS Kempton

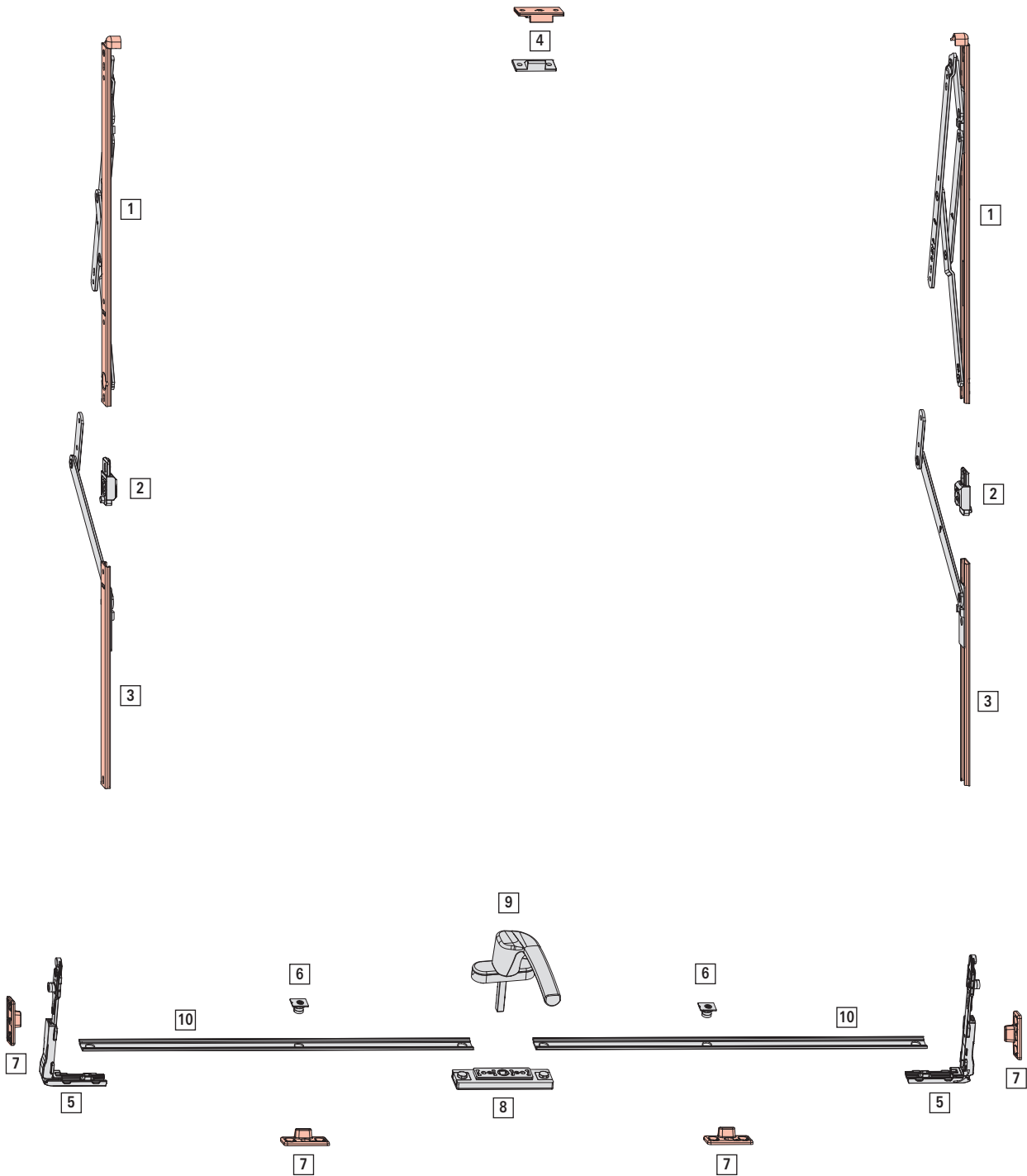

Position	Description
[1]	Friction stay → <i>from page 52</i>
[2]	Height adjustment → <i>from page 58</i>
[3]	Opening restrictor → <i>from page 59</i>
[4]	Concealed lock → <i>from page 64</i>
[5]	Corner drive → <i>from page 107</i>
[6]	Cam → <i>from page 105</i>
[7]	Striker → <i>from page 105</i>
[8]	Rebate espagnolette → <i>from page 109</i>
[9]	Handle, see CTL_1
[10]	Connecting rod → <i>from page 110</i>

For compatible locking systems, see → *from page 88*



INFO

Limit the espagnolette or connecting rod to 90°.



INFO

Friction stays: dimensions (SRW / SRH) on facade windows from glass edge to glass edge, on conventional windows from sash rebate to sash rebate.

2.1.4.3 Top-Hung

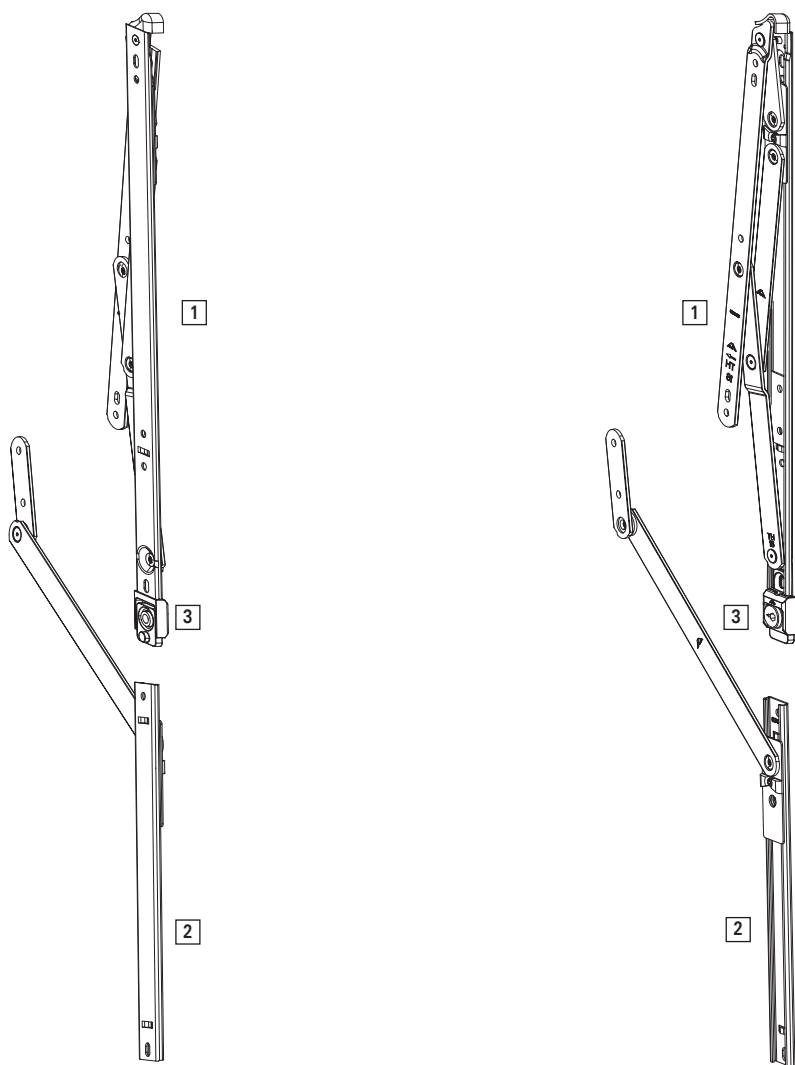

Position	Description
[1]	Friction stay → <i>from page 52</i>
[2]	Opening restrictor → <i>from page 59</i>
[3]	Height adjustment → <i>from page 58</i>

For compatible locking systems, see → *from page 88*



2.1.4.4 Side-Hung

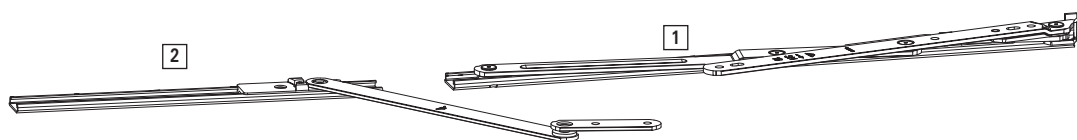
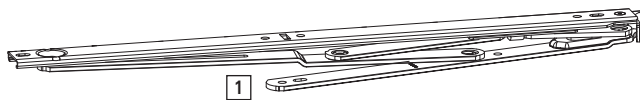

Position	Description
[1]	Friction stay → <i>from page 52</i>
[2]	Opening restrictor → <i>from page 59</i>

For compatible locking systems, see → *from page 88*

2.1.5 Friction stays

2.1.5.1 HX



Product description

- Self-balancing friction stay.
- Can be used for Top-Hung and Side-Hung.
- Asymmetrical stainless-steel retraction mechanism and end stop with PVC, to prevent direct contact with metal, for superior durability and wear resistance.
- PVC-encased slider for high level of durability and low wear.
- Adjustable opening stop for all Top-Hung scissor stays.

Performance specification

- Resistance to repeated opening and closing: H3
- Corrosion resistance: 5; austenitic stainless steel

Scope of delivery

- In pairs
 (left + right friction stay)

Required sash, frame and rebate clearance dimensions

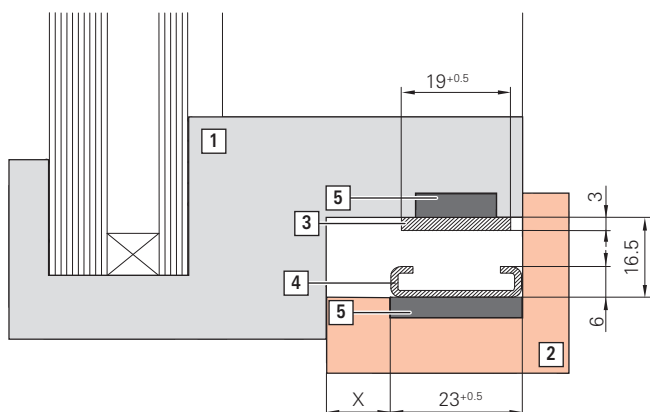

- [1] Sash
Cutting ± 1 mm
- [2] Scissor stay arm
- [3] Frame
Cutting ± 1 mm
- [4] Guide track
- [5] Pressure-resistant packer, if required
- [X] As small as possible



Top-Hung

									Nº
HX TH / SH 8	212	23	16	300 – 450	35 kg	50	–	25 Pair(s)	785740
HX TH 10	261	23	16	300 – 650	35 kg	40	–	25 Pair(s)	823192
HX TH 12	305	23	16	450 – 800	45 kg	40	–	25 Pair(s)	823193
HX TH 14	353	23	16	600 – 950	50 kg	40	–	20 Pair(s)	823194
HX TH 16	414	23	16	750 – 1250	65 kg	50	–	20 Pair(s)	823195
HX TH 22	565	23	16	1100 – 1500	100 kg	20	500	20 Pair(s)	823196
HX TH 24	613	23	16	1200 – 1800	120 kg	20	500	10 Pair(s)	823197
HX TH 26	666	23	16	1450 – 2500	180 kg	20	500	10 Pair(s)	823198



INFO

Height adjustment is recommended for S.kg \geq 100 kg. Profile assessment required.

Side-Hung

								Nº
HX TH / SH 8	212	23	16	300 – 400	35 kg	50	25 Pair(s)	785740
HX SH 10	261	23	16	350 – 450	40 kg	87	25 Pair(s)	823188
HX SH 12	312	23	16	380 – 570	40 kg	87	25 Pair(s)	823189
HX SH 14	357	23	16	500 – 600	40 kg	87	20 Pair(s)	823190
HX SH 16	413	23	16	550 – 750	45 kg	87	20 Pair(s)	823191

2.1.5.2 LB

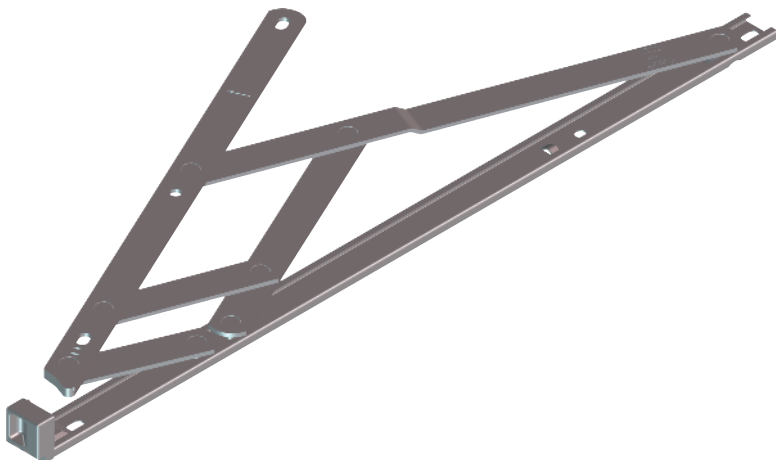

Product description

- For Side-Hung and Top-Hung applications.
- Simple setting and adjustment of brake force.
- Sealed slider for effortless operation.
- Integrated retraction mechanism protects against the ingress of dirt and enables a greater rebate-clearance tolerance.
- Improved sealing against weather conditions and gusts of winds due to integrated retraction mechanism and asymmetrical scissor stay arm.

Scope of delivery

- In pairs
 (left + right friction stay)

Performance specification

- Functional test with 30,000 cycles.
- Ferritic stainless steel for normal corrosion resistance.

Required sash, frame and rebate clearance dimensions

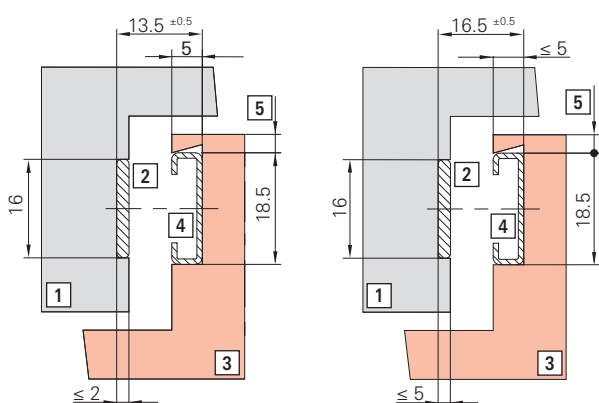

- [1] Sash
- [2] Sash arm
- [3] Frame
- [4] Track
- [5] As small as possible for best possible operation

Top-Hung

	LB TH 08-F	209	18	13	200 – 350	12 kg	65	25 Pair(s)	318423
	LB TH 08-F-S16	209	18	16	200 – 350	12 kg	65	25 Pair(s)	318431
	LB TH 10-F	259	18	13	275 – 400	16 kg	80	25 Pair(s)	318424
	LB TH 10-F-S16	259	18	16	275 – 400	16 kg	80	25 Pair(s)	318432



								N ^o
LB TH 12-F	310	18	13	350 – 550	20 kg	80	25 Pair(s)	318425
LB TH 12-F-S16	310	18	16	550 – 650	20 kg	80	25 Pair(s)	318433
LB TH 16-F	412	18	13	500 – 780	21 kg	80	25 Pair(s)	318426
LB TH 16-F-S16	412	18	16	500 – 780	21 kg	80	25 Pair(s)	318434
LB TH 20-F	513	18	13	700 – 1100	26 kg	50	25 Pair(s)	318427
LB TH 20-F-S16	513	18	16	700 – 1100	26 kg	50	25 Pair(s)	318435
LB TH 24-F	615	18	13	850 – 1300	40 kg	38	25 Pair(s)	318428
LB TH 24-F-S16	615	18	16	850 – 1300	40 kg	38	25 Pair(s)	318436

Side-Hung

								N ^o
LB SH 12-F	310	18	13	300 – 600	22 kg	60	25 Pair(s)	318429
LB SH 12-F-S16	310	18	16	300 – 600	22 kg	60	25 Pair(s)	318437
LB SH 16-F	412	18	13	400 – 700	24 kg	60	25 Pair(s)	318430
LB SH 16-F-S16	412	18	16	400 – 700	24 kg	60	25 Pair(s)	318438

2.1.5.3 LM

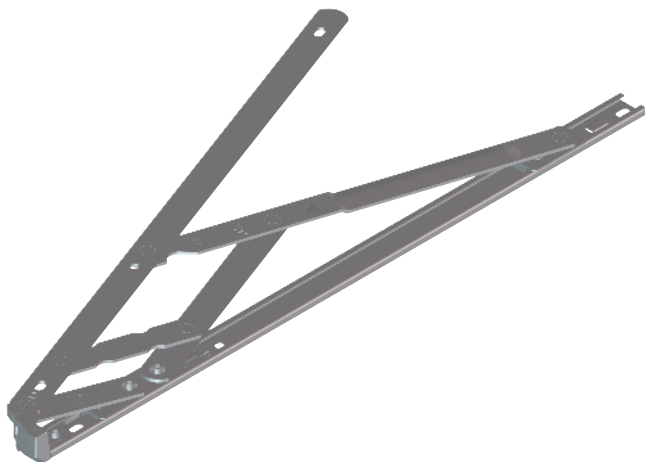

Product description

- Self-lubricating end cap for effortless closing.
- Self-lubricating sliders for effortless operation.
- Release function enables cleaning from the inside of the building.
- Can be used for Side-Hung.
- Simple setting and adjustment of brake force.

Scope of delivery

- In pairs
 (left + right friction stay)

Performance specification

- Opening angle up to 90°.
- Functional test with 50,000 cycles.
- Austenitic stainless steel for high corrosion resistance.
- For sash weights up to 24 kg in Side-Hung applications.

Required sash, frame and rebate clearance dimensions

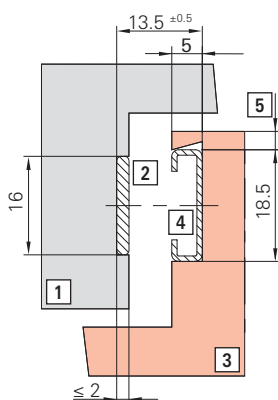

- [1] Sash
- [2] Sash arm
- [3] Frame
- [4] Track
- [5] As small as possible for best possible operation

Side-Hung

LM SH 12		310	18	13	300 – 600	22 kg	80	25 Pair(s)	318470
LM SH 16		413	18	13	400 – 700	24 kg	90	25 Pair(s)	318471



2.1.6 Turn-Only hinge

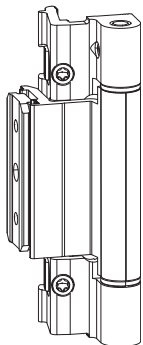

Product description



- Hinge passage > 3.5 mm
- Hardware axis: 10 mm
- Integrated anti-lifting device
- Weatherproof and UV-resistant

Scope of delivery



- Individually







Application range

Top-Hung

		Up to three hinges	Up to five hinges
	Sash height	425 – 1200 mm	550 – 2000 mm
	Sash width	525 – 2400 mm	800 – 2000 mm
	Sash weight	max. 70 kg	max. 100 kg

Side-Hung

Up to three hinges		
	Sash height	520 – 2250 mm
	Sash width	405 – 1400 mm
	Sash weight	max. 70 kg

						Nº
10	max. 100 kg	Clamp strip version no. 1	R01.5	Silver	10 Piece(s)	794194
		Clamp strip version no. 1	R07.2	Traffic white	10 Piece(s)	794205
		Clamp strip version no. 1	R00.0	Uncoated	10 Piece(s)	794206
		Clamp strip version no. 2	R01.5	Silver	10 Piece(s)	780718
		Clamp strip version no. 2	R07.2	Traffic white	10 Piece(s)	780719
		Clamp strip version no. 2	R00.0	Uncoated	10 Piece(s)	780720



INFO

Other RAL colours and clamp strips are available upon request.

2.1.7 Accessories

2.1.7.1 Height adjustment

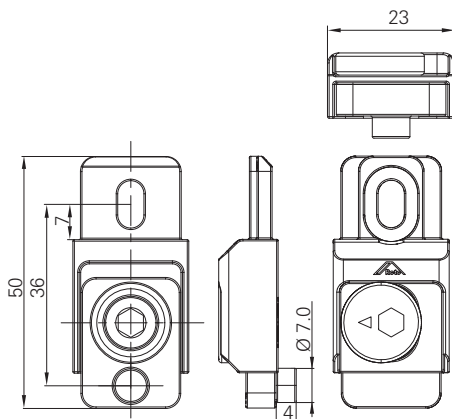



Product description

- Recommended for Roto FS Kempton HX heavy-duty friction stays (Top-Hung) with sash weights ≥ 100 kg.
- Height adjustment ± 2 mm.
- Enables heavy sashes to be simply aligned on the construction site.
- Operation with hex key.

Scope of delivery

- Bag
2 pieces per bag

		Nº
Height adjustment	50	857579



2.1.7.2 Opening restrictor

2.1.7.2.1 RD comfort opening restrictor

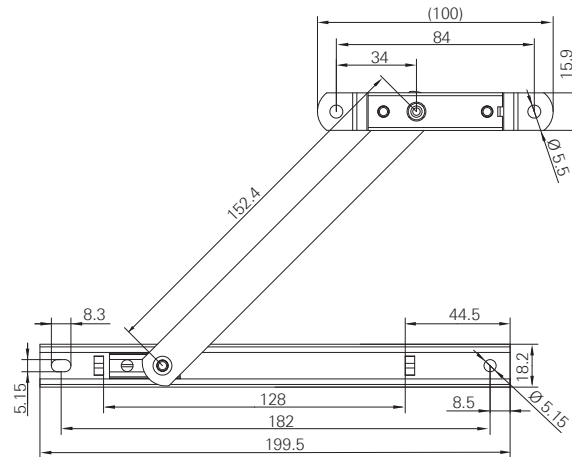

Product description

- Comfort opening restrictor for heavy-duty sashes (industrial applications).
- Enables the sash to be opened until the slider engages at the gap aperture stop on the guide track.
The user can release the restrictor using the release key.
- Can be used on the right and left.
- Slider made from composite material and stainless steel for maximum strength with effortless operation.
- Increases friction when opening and closing the window.
- Unique locking cam enables the opening restrictor to engage and be released simply.

Scope of delivery

- Individually
- Release key



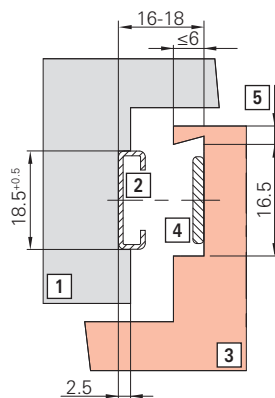

Performance specification

- Resistance when opening in restricted position: 1000 N.
- Austenitic stainless steel for improved corrosion resistance.

Required sash, frame and rebate clearance dimensions



- [1] Sash
- [2] Sash arm
- [3] Frame
- [4] Track
- [5] As small as possible for best possible operation

					N ^o
RD TS 04	200	18	16	50 Piece(s)	767002
RD TS 06	200	18	16	50 Piece(s)	485433
RD TS 08	200	18	16	50 Piece(s)	485439
Release key	-	-	-	100 Piece(s)	485440

2.1.7.2.2 RH opening restrictor

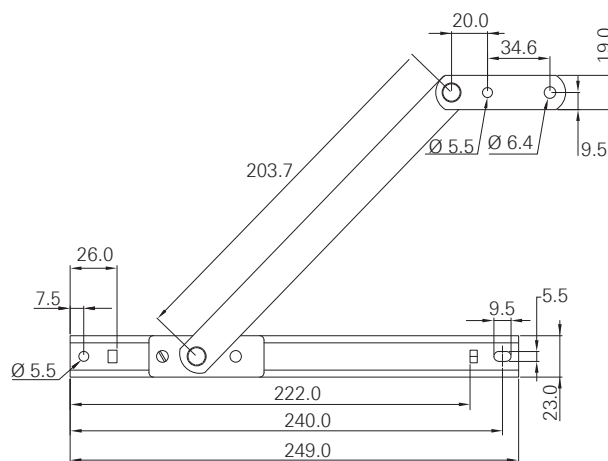

Product description

- Opening restrictor for heavy-duty sashes (industrial applications).
- Enables the permanent opening restriction of open sashes.
- Can be used on the right and left.
- Increases friction when opening and closing the window.

Scope of delivery

- Individually

Performance specification

- Austenitic stainless steel for improved corrosion resistance.

Required sash, frame and rebate clearance dimensions

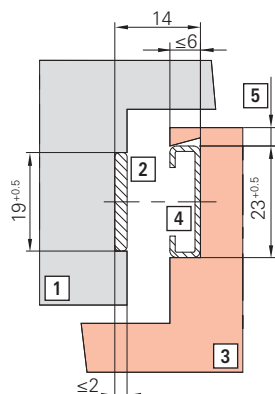

- [1] Sash
Cutting ±1 mm
- [2] Frame
Cutting ±1 mm
- [3] Scissor stay arm
- [4] Guide track
- [5] Pressure-resistant packer, if required

				N ^o
249	23	16	50 Piece(s)	785746



2.1.7.2.3 RL opening restrictor

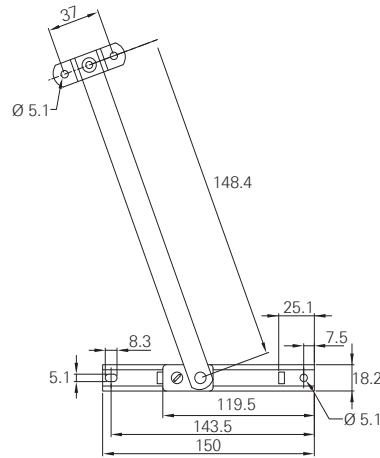

Product description

- Lightweight standard opening restrictor for private applications.
- Can be used on the right and left.
- Increases friction when opening and closing the window.

Performance specification

- Resistance (for one minute): 350 N.
- Ferritic stainless steel for normal corrosion resistance.

Scope of delivery

- Individually

Required sash, frame and rebate clearance dimensions

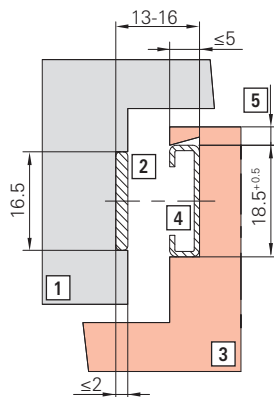

- [1] Sash
- [2] Sash arm
- [3] Frame
- [4] Track
- [5] As small as possible for best possible operation

						Nº
RL TS 06-F	150 mm	18	13	50 Piece(s)	318474	

2.1.7.2.4 Opening restrictor SOR

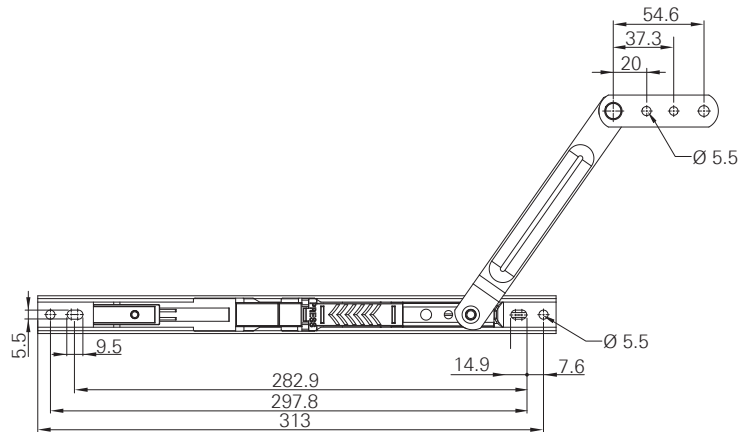
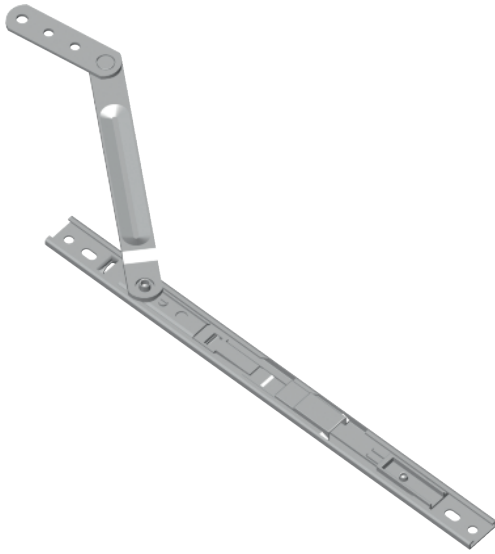

Product description

- Reliable locking of the sash (multi-stage locking function) in the selected opening position.
- Prevents the sash from slamming shut or swinging open in gusts of wind.
- Can be combined with friction stays from the HX TH series in sizes of 16", 22" and 26".
- Can be used on the right and left.

Performance specification

- Austenitic stainless steel for improved corrosion resistance.

Scope of delivery

- Individually

Required sash, frame and rebate clearance dimensions

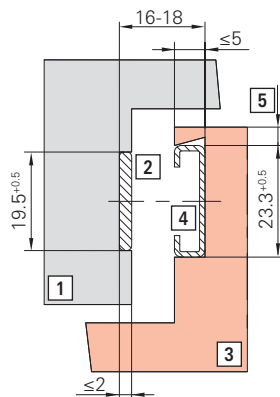

- [1] Sash
- [2] Sash arm
- [3] Frame
- [4] Track
- [5] As small as possible for best possible operation

SOR 150		150	23	16	50 Piece(s)	799785
SOR 300		300	23	16	40 Piece(s)	799786
SOR 400		400	23	16	20 Piece(s)	799787



2.1.7.2.5 RC opening width restrictor

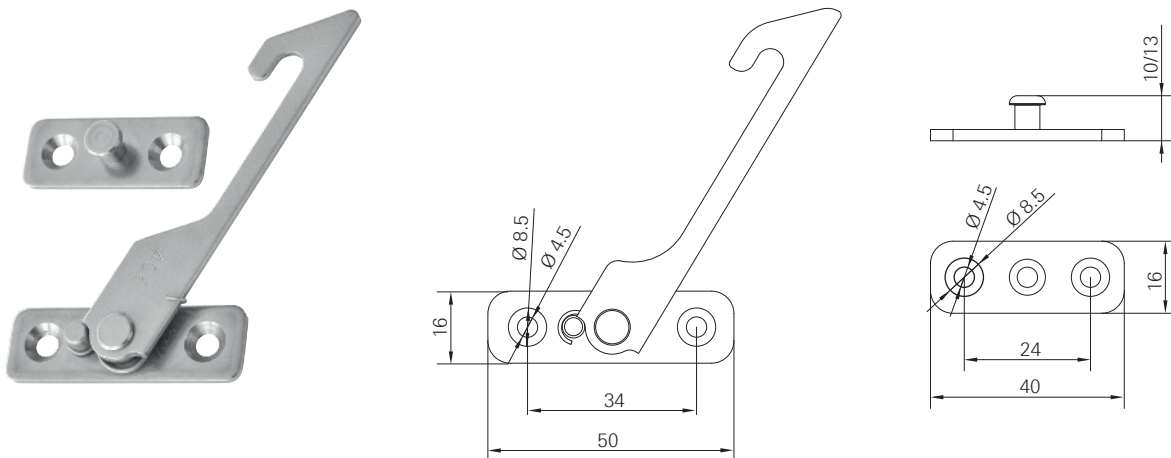

Product description

- Lightweight standard opening restrictor for private applications involving Side-Hung windows.
- Can be used on the right and left.
- Limits Side-Hung windows to a maximum opening width of 100 mm.
- For windows even without reinforcements.
- Easy to install

Performance specification





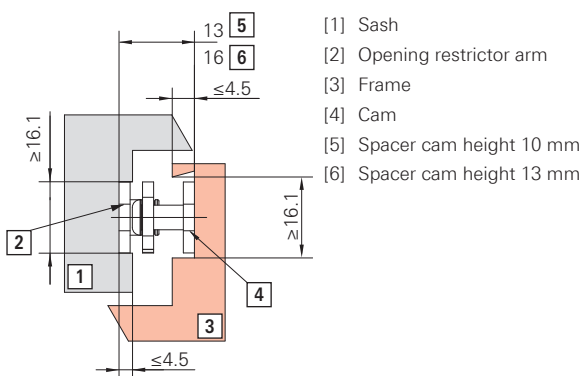

- Resistance when opening in restricted position: 600 N
- Austenitic stainless steel for improved corrosion resistance.

Scope of delivery

- Individually

Required sash, frame and rebate clearance dimensions



						No
Side-Hung	-	Sash	Left	-	25 Piece(s)	485441
	-	Sash	Right	-	25 Piece(s)	485442
	Positioning pin, 13 mm	Frame	-	9.5	25 Piece(s)	485443
	Positioning pin, 16 mm	Frame	-	13.5	25 Piece(s)	485444

2.1.7.3 Concealed lock

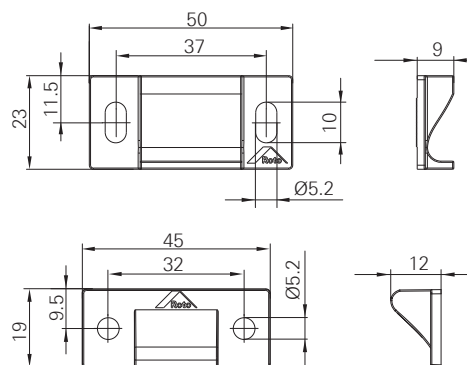

Product description

- Concealed lock for increased weather resistance and security.
- Reduces deformation of large Top-Hung sashes caused by wind loads.
- Takes additional load away from the friction stays.
- No need to drill or mill the profile.
- Adjustable frame component for improved gasket compression.

Scope of delivery

- 1 set
 (1 frame component / 1 sash component)

Packers		
For frame profile with groove		
For sash profile with groove		
For frame profile without groove		



INFO

Do not use on sash profiles without C-groove packer.



Set 1

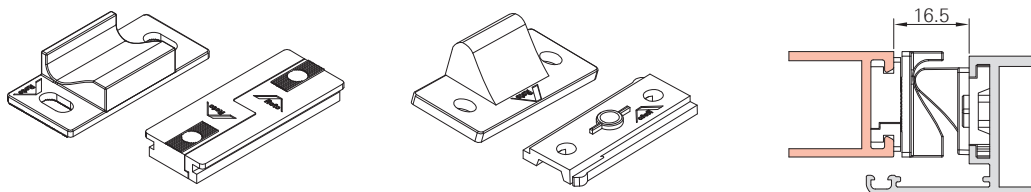

Set 2

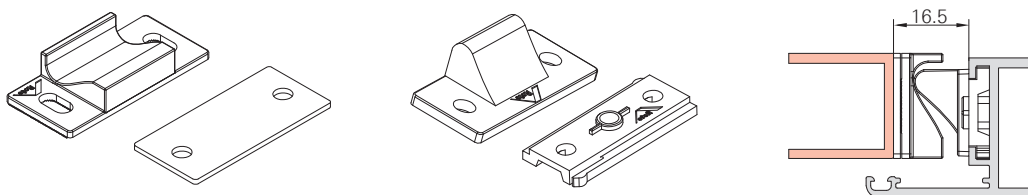

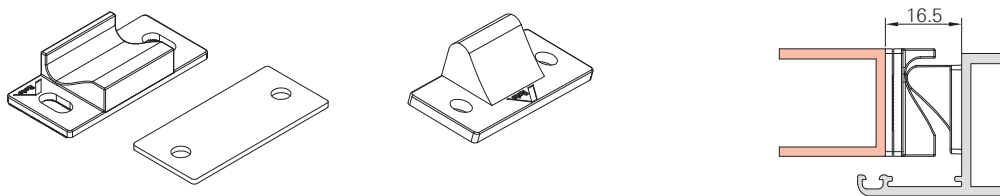

With a larger rebate clearance, fit additional packers.

Set 3



With a larger rebate clearance, fit additional packers.

			N ^o
	Set 1: for sash and frame profile with groove	1 Set(s)	771865
	Set 2: for sash profile with groove and frame profile without groove	1 Set(s)	771866
	Set 3: for sash and frame profile without groove	1 Set(s)	771867

2.1.7.4 Anti-lifting device

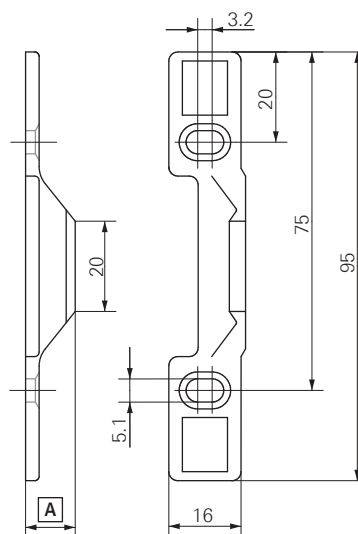



Product description

- Anti-lifting device for reinforcing the hinge side of the window sash.
- For windows on the ground floor or windows on higher floors which are easy to access from the outside due to a flat roof, for example, in private and normal industrial areas.
- Contactless, which means a reduced risk of crushing and being caught during normal window operation.
- No need to drill or mill the profile.

Scope of delivery

- 1 set (4 pieces: 2 frame components / 2 sash components)

			N ^o
	Anti-jemmy device, 13 mm	50 Set(s)	485599
	Anti-jemmy device, 16 mm	50 Set(s)	485600

2.2 Roto PS Aintree

2.2.1 General hardware characteristics

2.2.1.1 Parallel projecting scissor stays

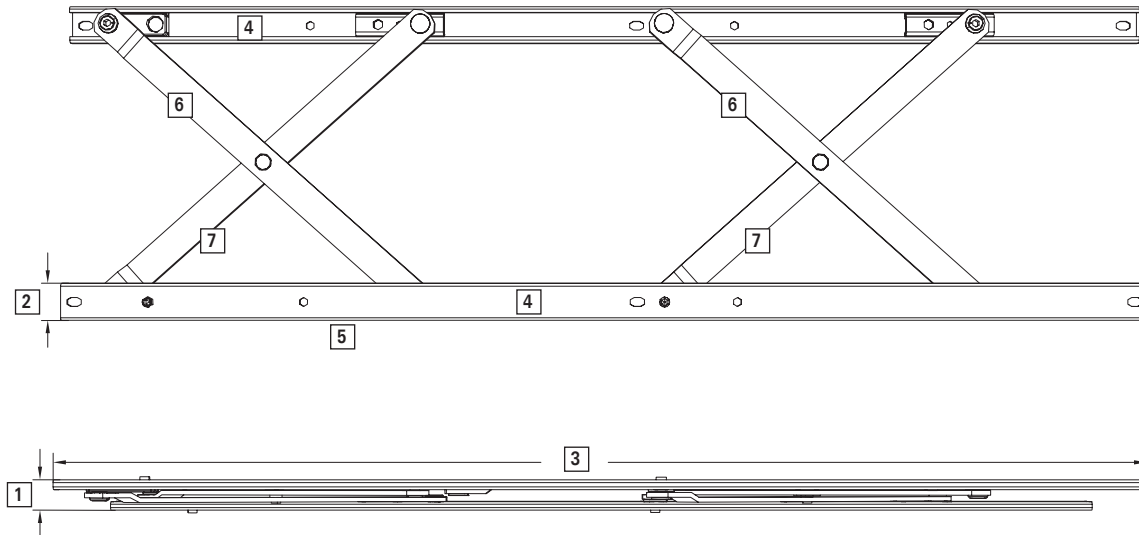

- [1] Scissor stay installation height [3] Scissor stay length [5] Guide track [7] Second scissor stay link
[2] Scissor stay width [4] Slider [6] First scissor stay link

Technical features

- Stainless-steel parallel projecting scissor stays for outward opening windows.
- Parallel movement of the window sash relative to the facade.
- Tested over 20,000 cycles.
- Any sash shapes can in principle be implemented.
- Max. sash height: 3000 mm.
- Max. sash width: 1500 mm.
- Max. sash weight: 200 kg.
- Opening width in manual mode: 150 mm.

Advantages

- Outward opening window sashes can be implemented in any shape, enabling fabricators to extend the application range.
- Parallel projecting scissor stays enable much higher air exchange rates and provide natural ventilation.
- Parallel projecting scissor stays are made from austenitic stainless steel and can be used in challenging climatic conditions.
- Tight sealing in outward opening windows.
- High-performance components are used in the entire scissor stay area. This achieves high operational reliability.

Benefits

- Simple, reliable operation.
- Ten-year performance warranty.
- Entire room can be used because the window opens outward.

Use

Roto PS Aintree parallel projecting scissor stays were designed for aluminium windows. The scissor stays have a symmetrical design so that they use the entire length of the scissor stay guide for joint guidance. All mounting holes must be used for optimum implementation and sealing.

Positioning and rebate clearance

- Roto PS Aintree parallel projecting scissor stays are designed to be installed between two parallel, fixed surfaces with a constant rebate clearance distance, whose dimensions correspond to the specifications in this document.
- If the profile does not have any parallel surfaces for installing the scissor stay, packers or adapters must be used to adapt the scissor stay space in accordance with requirements (see drawings).
- The scissor stay space between the sash and frame must meet the requirements defined in this document (see drawings).

Sash formats

The stated maximum sash heights and widths must be adhered to. If the maximum sash heights or widths are exceeded, the profile manufacturer must be consulted for their recommendations with regard to the stability of the profile system and weather resistance of the seal system.

Corrosion resistance

Roto PS Aintree scissor stays are made of austenitic stainless steel and have a high level of corrosion resistance and are therefore suitable for use in the industrial sector or in coastal regions. They meet the requirements of BS EN ISO 9227 / BS EN 1670 and continue to function properly even after a 500-hour neutral salt spray test. This may cause colour deviations on the surface, but these do not impair correct functioning.

Easy to install

Roto PS Aintree is designed to be as adaptable as possible in window production. Flexible mounting points enable simple, fast and yet correct installation.

Long service life

The Roto PS Aintree scissor stay system uses high-performance components which guarantee longer than average operational reliability and service life.

Limiting the opening width

An opening restrictor is used when the parallel projecting scissor stays are operated manually. All parallel projecting scissor stays have a max. opening width of 150 mm in combination with an opening restrictor. The exception is HX PH 250 with a max. opening width of 120 mm.

System inspection – Correct application

A theoretical and practical profile assessment is generally recommended before manufacturing windows. Roto Frank Fenster- und Türtechnologie GmbH will assist in this profile assessment if required. Please contact your responsible Roto sales representative.

It is the responsibility of the manufacturer and installer of the window or facade to ensure that both the material and design of the frame and sash, as well as the way in which the hardware is attached, complies with the requirements of the installation situation and environment. For instance, the attachment material used (screws and / or rivets) must be suitable for proper use in the corresponding frame material (aluminium).

It is also the responsibility of the planner, designer, manufacturer and installer of the window or facade to ensure that the finished structure complies with the stipulated requirements and local building regulations and that a risk assessment is performed to define the security requirements for the building, taking into consideration the local building regulations and the intended use of the building.

Roto Frank Fenster- und Türtechnologie GmbH assumes no liability for any damage or loss resulting from failure to comply with the specifications stated in this document and other associated documents or in the event that the processing procedure does not comply with regulations during use of Roto PS Aintree.



2.2.1.2 Opening restrictor for parallel projecting windows

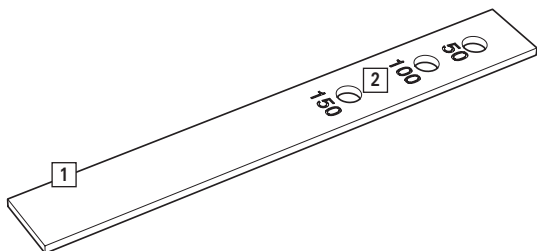

- [1] Frame component
- [2] Opening width

Use

The opening restrictor limits the opening width to 150 mm on all parallel projecting scissor stays. The exception is HX PH 250, which has a max. opening width of 120 mm.

Operation

During opening, the sliders move in the guide track on the frame until they are blocked by the opening restrictor and the maximum opening width is reached.

Positioning and rebate clearance

- The scissor stay space between the sash and outer frame or upstand must meet the requirements for opening restrictors defined in this document (see drawings).

Using the opening restrictor

The opening restrictors are installed in pairs in the guide track on the frame. Please note the corresponding markings for setting the required opening width.

2.2.2 Application diagrams

2.2.2.1 PS Aintree HX

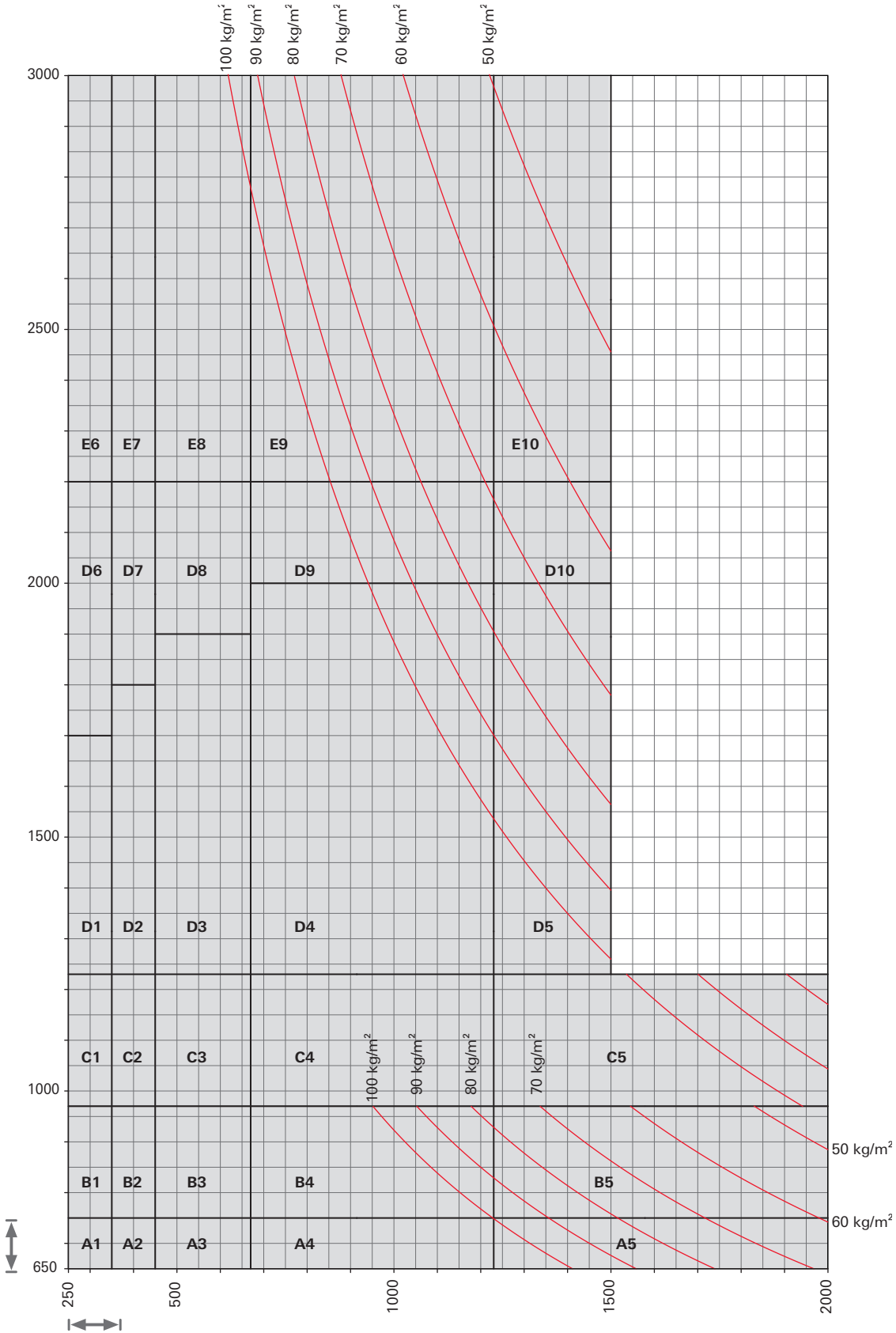



 = Impermissible application range

The specifications in the application diagram refer to the glass weight in kg/m² and are based on the calculated profile weight of 2 kg/m.

1 mm/m² glass thickness \approx 2.5 kg



Parallel projecting scissor stays at the side					Control scissor stays		
	Left	Right	Opening restrictor	Max. weight		Top	Bottom
A	1 x HX PH 350	1 x HX PH 350	2 x 605569	100 kg	1	1 x HX PH 250 R	–
B	1 x HX PH 450	1 x HX PH 450	2 x 605571	100 kg	2	1 x HX PH 350 R	–
C	1 x HX PH 670	1 x HX PH 670	2 x 605571	200 kg	3	1 x HX PH 450 R	–
D	1 x HX PH 950	1 x HX PH 950	2 x 605570	200 kg	4	1 x HX PH 670 R	–
E	2 x HX PH 950	2 x HX PH 950	4 x 605570	200 kg	5	1 x HX PH 950 R	–
					6	1 x HX PH 250 R	1 x HX PH 250 R
					7	1 x HX PH 350 R	1 x HX PH 350 R
					8	1 x HX PH 450 R	1 x HX PH 450 R
					9	1 x HX PH 670 R	1 x HX PH 450 R
					10	1 x HX PH 950 R	1 x HX PH 450 R



INFO

When using HX PH 250 as a control scissor stay at the top or bottom, opening restrictor 792182 must be installed → *from page 77*.

Application range

Application range		
	Sash rebate width	250 – 2000 mm
	Sash rebate height	650 – 3000 mm
	Sash weight	max. 200 kg



INFO

The stated sizes refer only to the load-bearing capacity of the parallel projecting scissor stays. Profile limitations due to window formats are not taken into consideration in this illustration and must be checked separately by the window manufacturer.

2.2.3 Hardware overviews



INFO

All hardware overviews shown in this chapter are for illustration purposes only. Please refer to the applicable installation instructions for exact specifications and installation advice.



2.2.3.1 PS Aintree

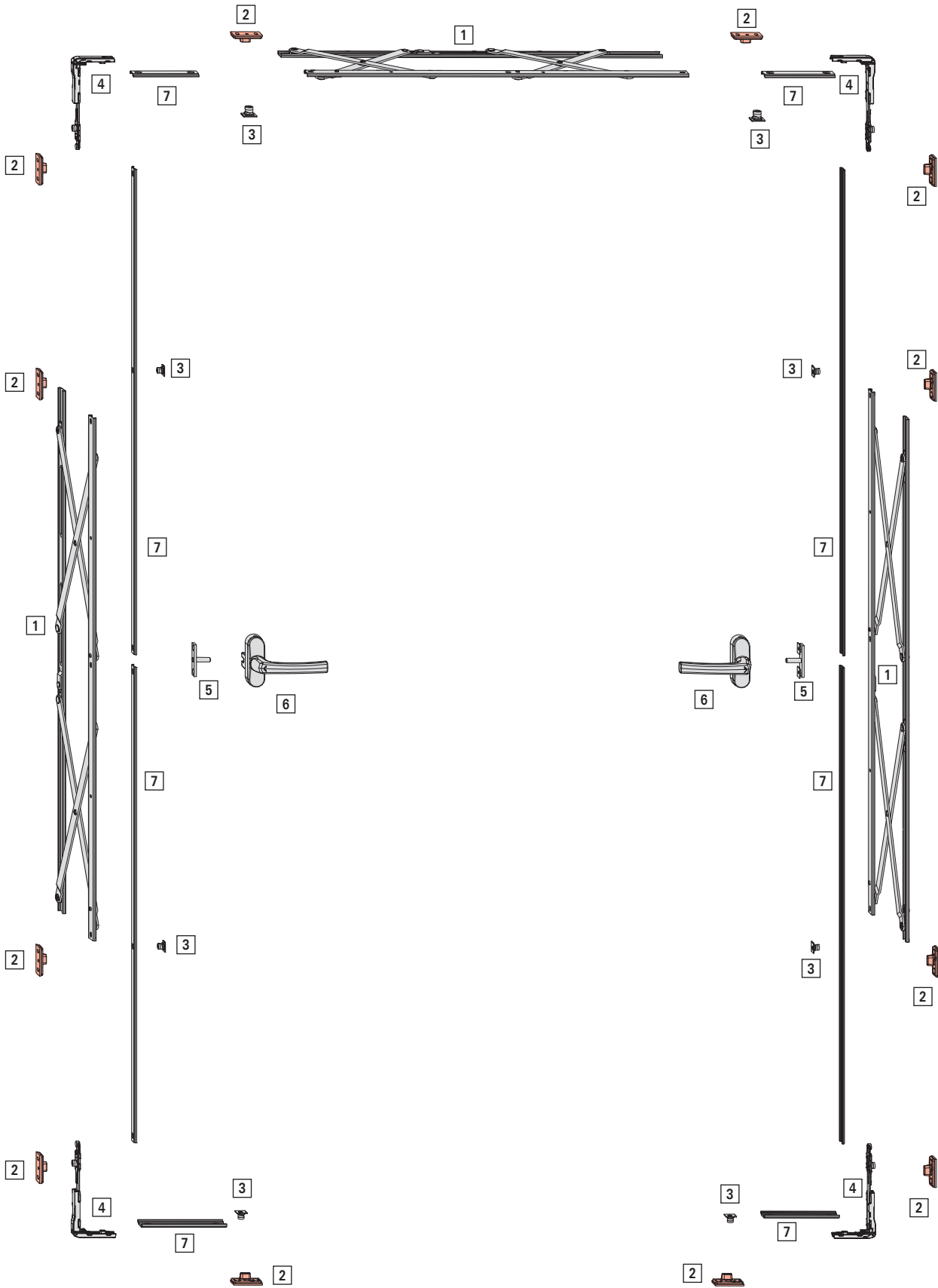





Position	Description
[1]	Parallel projecting scissor stay → <i>from page 75</i>
[2]	Striker → <i>from page 105</i>
[3]	Insertable cam → <i>105</i>
[4]	Corner drive → <i>from page 107</i>
[5]	Espagnolette
[6]	Handle, see CTL_1
[7]	Connecting rod → <i>from page 110</i>

For compatible locking systems, see → *from page 88*

Application range

Application range		
	Sash rebate width	250 – 2000 mm
	Sash rebate height	650 – 3000 mm
	Sash weight	200 kg



2.2.4 Parallel projecting scissor stays

2.2.4.1 HX



Product description

- Heavy-duty parallel projecting scissor stay for industrial applications
- Optimum air exchange due to all-round window opening

Performance specification

- Functional test with 20,000 cycles
- Austenitic stainless steel for high corrosion resistance.







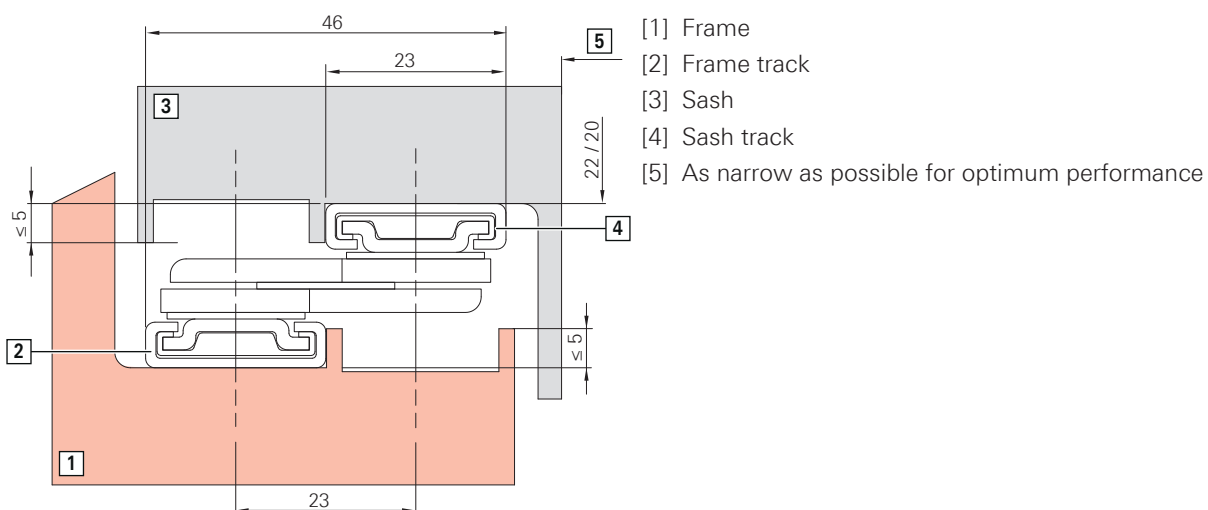

Scope of delivery

- Individually
Including adjustment fastening

Required sash, frame and rebate clearance dimensions



HX PH 250	262	23	20	-	120 mm	Right	25 Piece(s)	605530

								Nº
HX PH 350	350	23	20	100 kg	150 mm	Right	25 Piece(s)	605531
	350	23	20	100 kg	150 mm	Left	25 Piece(s)	605532
HX PH 450	450	23	20	100 kg	150 mm	Right	25 Piece(s)	605533
	450	23	20	100 kg	150 mm	Left	25 Piece(s)	605534
HX PH 670	670	23	20	200 kg	150 mm	Right	10 Piece(s)	605565
	670	23	20	200 kg	150 mm	Left	10 Piece(s)	605566
HX PH 950	925	23	20	200 kg	150 mm	Right	10 Piece(s)	605567
	925	23	20	200 kg	150 mm	Left	10 Piece(s)	605568



INFO

The HX PH 250 parallel projecting scissor stay must exclusively be used as a control scissor stay.

2.2.5 Accessories

2.2.5.1 Adjustment fastening

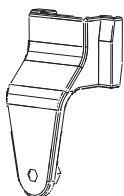



Product description

- The adjustment fastening is fitted to the track of the parallel projecting scissor stay to prevent the parallelism from becoming misaligned.

Scope of delivery

- 1 bag (4 pieces)

		Nº
Adjustment fastening	100	792183



2.2.5.2 Opening restrictor

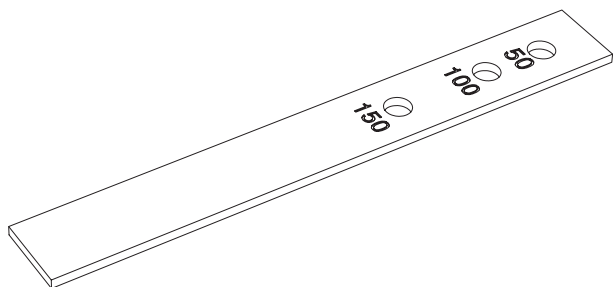

Product description

- The opening restrictor limits the opening width in specific intervals up to 150 mm.

Scope of delivery

- Individually

					Nº
	HX PH 350	40	150	100 Piece(s)	605569
	HX PH 670	71	150	100 Piece(s)	605571
	HX PH 250, HX PH 450 and HX PH 950	101	120	100 Piece(s)	792182
	HX PH 450 and HX PH 950	125	150	100 Piece(s)	605570

2.3 Roto FRH Uni

2.3.1 General hardware characteristics

2.3.1.1 Fully reversible hinges

Standard version

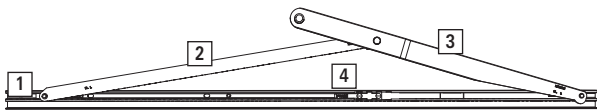

Hotel version

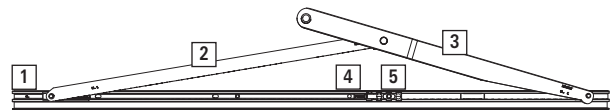

- [1] Track
- [2] Rotating arm
- [3] Sliding arm
- [4] Restrictor
- [5] Turn lock

Technical features

- Can be used for timber, PVC and aluminium profiles.
- Fully reversible hinges make it possible to turn the window 170°.
- Can be used for a variety of sash formats.
- Sash weights up to max. 80 kg.
- Surface: class 5 corrosion resistance (EN 1670).
- Continuous operation: class 5 = 25,000 cycles.
- Safety in use class 1.

Advantages

- Ease of installation thanks to the fast, simple and flexible production of windows; frame and sash can be installed separately.
- Emergency exit with minimal sash heights (from scissor stay size 8).
- Different lock-in positions to lock the window in various ventilation and cleaning positions.
- Tight sealing in outward opening windows.
- The hotel version makes it possible to easily close the sash in the tilt position without pressing the restrictor.

Benefits

- Simple, reliable operation.
- Integrated cleaning position enables simple cleaning.
- Ten-year performance warranty.
- Entire room can be used because the window opens outward.



2.3.2 Application diagrams

2.3.2.1 80 kg



INFO

80 kg is only possible with fully reversible hinges M17 and M18 in combination with topgliders type 2 and type 6.

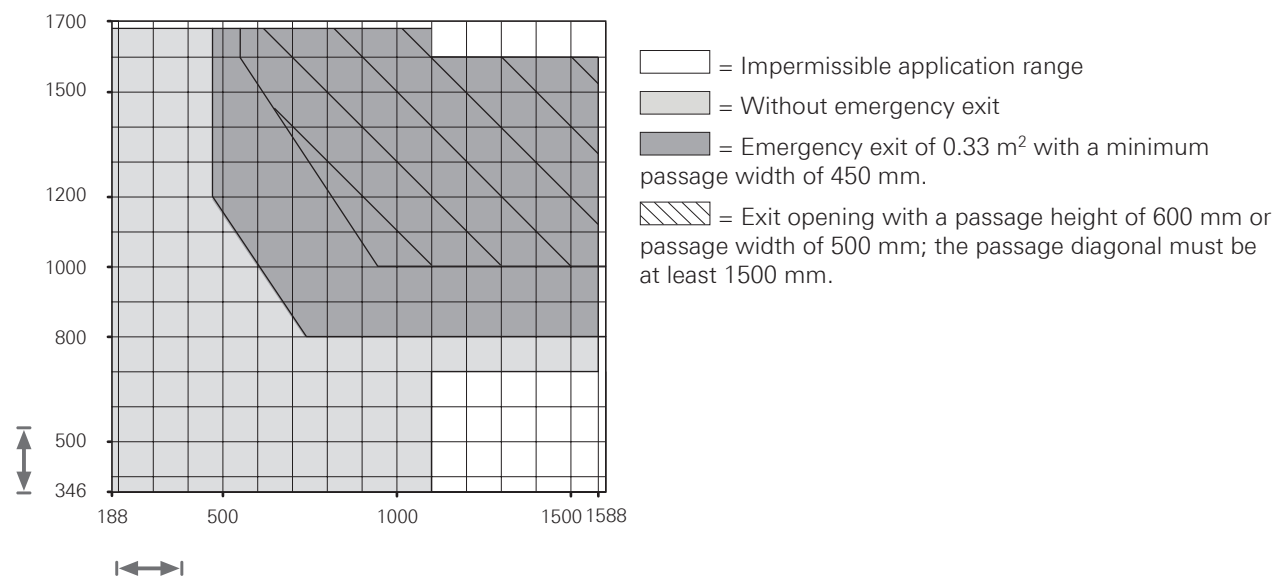

The specifications in the application diagram refer to the glass weight in kg/m².

1 mm/m² glass thickness \approx 2.5 kg

Application range 60 kg

Application range		
	Sash rebate width	188 – 1588 mm
	Sash rebate height	346 – 1688 mm
	Sash weight	Max. 60 kg

Application range 80 kg

Application range		
	Sash rebate height	1547 – 1688 mm
	Sash weight	Max. 80 kg

2.3.3 Hardware overviews



INFO

All hardware overviews shown in this chapter are for illustration purposes only. Please refer to the applicable installation instructions for exact specifications and installation advice.

2.3.3.1 Top-Swing

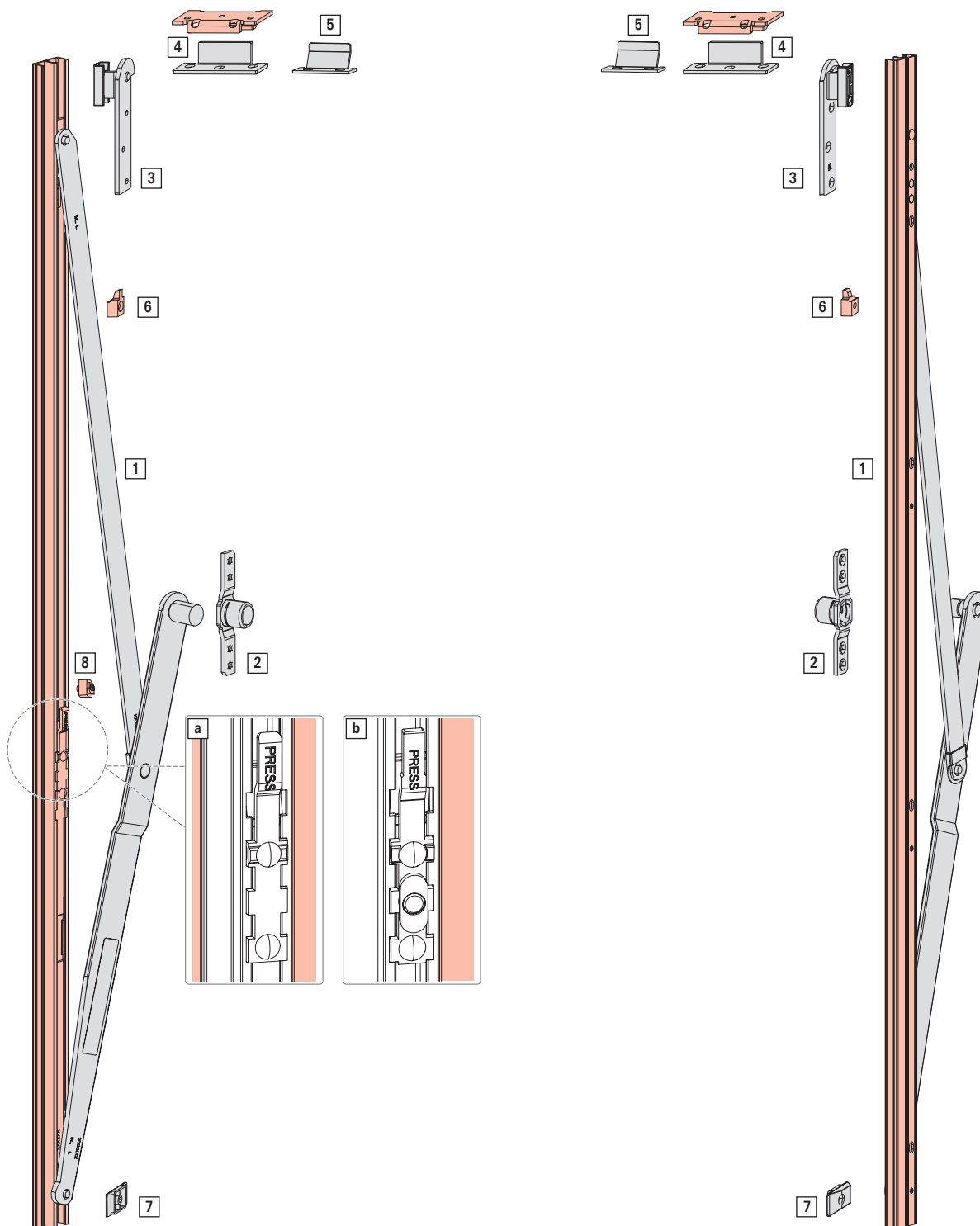



Position	Description
[a]	Standard version
[b]	Hotel version
[1]	Fully reversible hinge → <i>from page 81.</i>
[2]	Sash bearing → <i>from page 83.</i>
[3]	Topglider → <i>from page 84.</i>
[4]	Security component → <i>from page 85.</i>
[5]	Centre closer → <i>2.3.7.2 "Centre closer" from page 85.</i>
[6]	Guide block → <i>from page 86.</i>
[7]	Stop block → <i>from page 85.</i>
[8]	Blocking device → <i>from page 86.</i>

For compatible locking systems, see → *from page 88*

2.3.4 Fully reversible hinges



Product description

- Opening type: Top-Swing. Sash can be turned around completely.
- Can be used for timber, PVC and aluminium.
- Has two ventilation positions and two cleaning positions.
- Escape opening can be achieved even at low sash heights.
- Continuous operation class 5 (25,000 cycles).
- Corrosion class 5 (480 hours).
- Ease of use class 1.

Versions

- Standard

To move the sash out of a ventilation or cleaning position, the restrictor always has to be pressed. This means that the restrictor has to be actuated for opening, closing and turning the sash around.

- Hotel

Has a different restrictor but the scissor stay is otherwise identical to the standard version. Thanks to the restrictor, the sash can be closed by simply pulling it shut, in other words without actuating the restrictor. There is an additional integrated turn lock to nevertheless ensure safe ventilation.

Complies with the standards

- 13126-11

Scope of delivery

- Packaged in pairs
 Pair consists of 1 x fully reversible hinge with restrictor, left; 1 x fully reversible hinge, right
 Simple removal of the pairs ensured

Minimum order quantity





- 5 pairs

Standard





M5	424	60 kg	346 – 445	1 Pair(s)	777093	
M6	524	60 kg	446 – 525	1 Pair(s)	777527	
M6.5	580	60 kg	526 – 567	1 Pair(s)	777540	
M7	624	60 kg	568 – 625	1 Pair(s)	777528	
M7.5	680	60 kg	626 – 667	1 Pair(s)	777541	
M8	724	60 kg	668 – 725	1 Pair(s)	777529	

Stay systems
Roto FRH Uni
 Fully reversible hinges



					N ^o
M8.5	780	60 kg	726 – 767	1 Pair(s)	777542
M9	824	60 kg	768 – 825	1 Pair(s)	777530
M9.5	880	60 kg	826 – 867	1 Pair(s)	777543
M10	924	60 kg	868 – 925	1 Pair(s)	777531
M10.5	980	60 kg	926 – 967	1 Pair(s)	777544
M11	1024	60 kg	968 – 1025	1 Pair(s)	777532
M11.5	1080	60 kg	1026 – 1067	1 Pair(s)	777545
M12	1124	60 kg	1068 – 1125	1 Pair(s)	777533
M12.5	1180	60 kg	1126 – 1167	1 Pair(s)	777546
M13	1224	60 kg	1168 – 1225	1 Pair(s)	777534
M13.5	1280	60 kg	1226 – 1267	1 Pair(s)	777547
M14	1324	60 kg	1268 – 1325	1 Pair(s)	777535
M14.5	1380	60 kg	1326 – 1367	1 Pair(s)	777548
M15	1424	60 kg	1368 – 1425	1 Pair(s)	777536
M15.5	1480	60 kg	1426 – 1467	1 Pair(s)	777549
M16	1524	60 kg	1468 – 1546	1 Pair(s)	777537
M17	1624	80 kg	1547 – 1646	1 Pair(s)	777538
M18	1724	80 kg	1647 – 1688	1 Pair(s)	777539

Hotel

					N ^o
M5	424	60 kg	346 – 445	1 Pair(s)	777156
M6	524	60 kg	446 – 525	1 Pair(s)	777158
M6.5	580	60 kg	526 – 567	1 Pair(s)	777190
M7	624	60 kg	568 – 625	1 Pair(s)	777160
M7.5	680	60 kg	626 – 667	1 Pair(s)	777192
M8	724	60 kg	668 – 725	1 Pair(s)	777162
M8.5	780	60 kg	726 – 767	1 Pair(s)	777194
M9	824	60 kg	768 – 825	1 Pair(s)	777165
M9.5	880	60 kg	826 – 867	1 Pair(s)	777197
M10	924	60 kg	868 – 925	1 Pair(s)	777168
M10.5	980	60 kg	926 – 967	1 Pair(s)	777200
M11	1024	60 kg	968 – 1025	1 Pair(s)	777171
M11.5	1080	60 kg	1026 – 1067	1 Pair(s)	777203
M12	1124	60 kg	1068 – 1125	1 Pair(s)	777174
M12.5	1180	60 kg	1126 – 1167	1 Pair(s)	777206
M13	1224	60 kg	1168 – 1225	1 Pair(s)	777177
M13.5	1280	60 kg	1226 – 1267	1 Pair(s)	777209
M14	1324	60 kg	1268 – 1325	1 Pair(s)	777180
M14.5	1380	60 kg	1326 – 1367	1 Pair(s)	777212
M15	1424	60 kg	1368 – 1425	1 Pair(s)	777182
M15.5	1480	60 kg	1426 – 1467	1 Pair(s)	777214
M16	1524	60 kg	1468 – 1546	1 Pair(s)	777184
M17	1624	80 kg	1547 – 1646	1 Pair(s)	777186
M18	1724	80 kg	1647 – 1688	1 Pair(s)	777188



2.3.5 Sash bearing

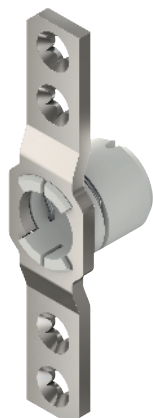

Product description



- Connects the fully reversible hinges in the middle to the window sash and enables turning.

Minimum order quantity

- 50 pieces

Scope of delivery

- 1 pair (2x sash bearings)

				N ^o
Type 1		PVC	1 Pair(s)	857654
Type 2		Timber	1 Pair(s)	857655
Type 3		Aluminium	1 Pair(s)	857656

2.3.6 Topglider



Product description

- Is installed on the window sash and guides the sash through the fully reversible hinge on the frame side when being turned around.

Minimum order quantity

- 50 pieces

Scope of delivery

- 1 pair
1 x topglider, left and 1 x topglider, right

Timber

							Nº
Type 1	Uninut	54	12	–	–	1 Pair(s)	777570
Type 2	Euronut 7/8 Euronut 11/8	54	16	–	–	1 Pair(s)	777557

Aluminium

			Nº
Type 2	Comar 5P.i Top Swing Reversible Smart Alitherm 700		1 Pair(s) 777557
Type 3	Kawneer AA®720 Reversible Window		1 Pair(s) 777225
Type 4	AluK Optio 58BW TSR top-swing-reversible Metal Technology High Performance Thermally Enhanced Top Swing Window Hydro Building Systems Dualframe 75 SI Reversible		1 Pair(s) 777223

PVC

			Nº
Type 5	Spectus Elite 70 Deceuninck FRW (Fully Reversible Window) Linjar Reversible Windows Profile 22 Fully Reversible Window Duraflex Fully Reversible Window		1 Pair(s) 777137
Type 6	Veka Halo Fully Reversible Window Veka Fully Reversible Window		1 Pair(s) 777268



				Nº
Type 7	Rehau Total70R Reversible window	1 Pair(s)	777272	
Type 8	LB Plastics Fully Reversible Window	1 Pair(s)	777101	

2.3.7 Accessories

2.3.7.1 Burglary protection

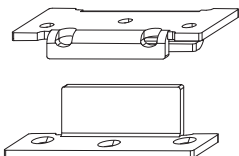

Product description

- Offers increased protection against unauthorised entry.

Minimum order quantity

- 50 pieces

				Nº
Minimum quantity per window: 2	Sash and frame component	Top	1 Set(s)	777555

2.3.7.2 Centre closer

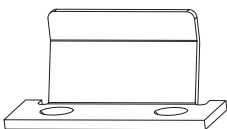

Product description

- Recommended for large window sashes to increase the gasket compression.

Minimum order quantity

- 20 pieces

				Nº
Minimum quantity per window: 2	Sash component	Top	1 Piece(s)	777524

2.3.7.3 Stop block

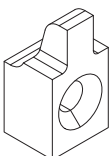

Product description

- As a precautionary measure, to restrict the backwards movement of the sash when cleaning in the cleaning position.

Minimum order quantity

- 100 pieces

			Nº
Minimum quantity per window: 2	Frame	1 Piece(s)	777554

2.3.7.4 Guide block

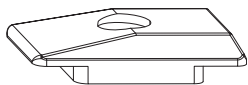

Product description

- Is installed on the side of the sash. Guides and keeps the sash at a right angle to the frame.

Minimum order quantity

- 100 pieces

			N ^o
Minimum quantity per window: 2	Sash	1 Piece(s)	777525

2.3.7.5 Blocking device

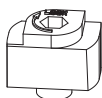

Product description



- If the blocking device is installed in the left aluminium track, it prevents the window sash being opened beyond the first ventilation position.

Scope of delivery

- 1x blocking device
- 1x hex key
- 1x set of installation instructions

Minimum order quantity

- 100 pieces

		N ^o
Frame	1 Set(s)	777573

Possible combinations

See page	88
----------	----

Roto SSL

Hardware overviews	89
Standard espagnolette	91
Strikers	92

Roto TSL

Hardware overviews	94
Reverse-action espagnolette – fixed handle height	96
Reverse-action espagnolette – centred / variable handle height	97
Strikers	98

Roto TSH

Hardware overviews	100
Espagnolette	101
Corner drives	101
Multipart centre locks	102
Shootbolt	102
Strikers	102
Accessories	103

Roto AL

Cam	105
Strikers	105
Corner drive without blocking device	107
Flush-encased gearbox	108
T connectors	109
TH connector	110
Coupler component set	110
Connecting rod	110

3 Locking systems

3.1 Possible combinations

The scissor stay systems can be combined with the following locking systems:

	FS Kempton			PS Aintree			FRH Uni		
	Aluminium	Timber	PVC	Aluminium	Timber	PVC	Aluminium	Timber	PVC
SSL	<input type="checkbox"/>	<input checked="" type="checkbox"/>	<input checked="" type="checkbox"/>	-	-	-	<input type="checkbox"/>	<input checked="" type="checkbox"/>	<input checked="" type="checkbox"/>
TSH	<input type="checkbox"/>	<input checked="" type="checkbox"/>	<input checked="" type="checkbox"/>	-	-	-	<input type="checkbox"/>	<input checked="" type="checkbox"/>	<input checked="" type="checkbox"/>
TSL	<input type="checkbox"/>	<input checked="" type="checkbox"/>	<input checked="" type="checkbox"/>	-	-	-	<input type="checkbox"/>	<input checked="" type="checkbox"/>	<input checked="" type="checkbox"/>
AL	<input checked="" type="checkbox"/>	-	-	<input checked="" type="checkbox"/>	-	-	<input checked="" type="checkbox"/>	-	-

■ = Standard, □ = Optional



3.2 Roto SSL

3.2.1 Hardware overviews



INFO

All hardware overviews shown in this chapter are for illustration purposes only. Please refer to the applicable installation instructions for exact specifications and installation advice.



3.2.1.1 SSL

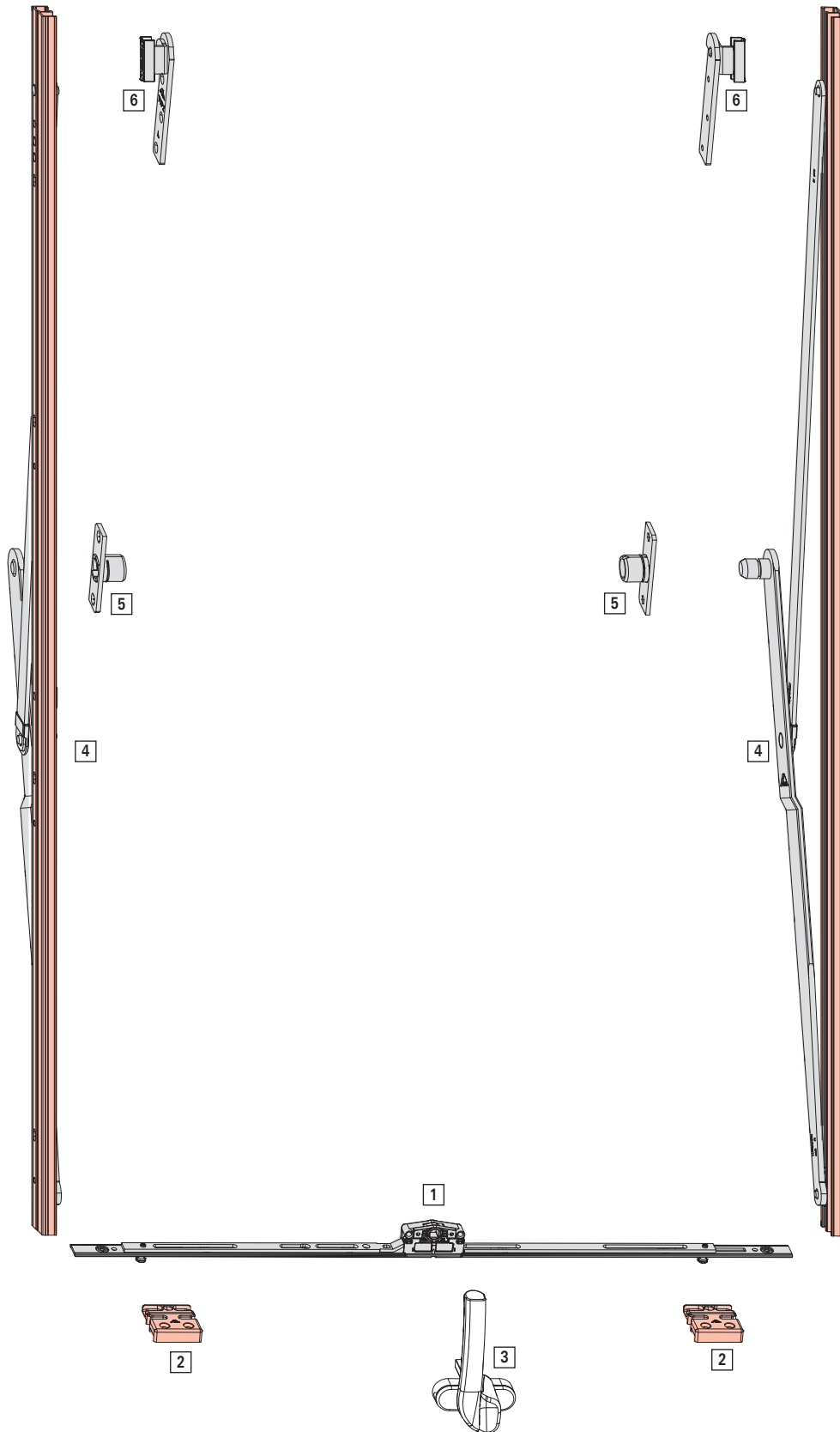

Position	Description
[1]	Espagnolette → <i>from page 91</i>
[2]	Strikers → <i>from page 92</i>



Position	Description
[3]	Handle, see CTL_1
[4]	Friction stay → <i>from page 52</i> Fully reversible hinge → <i>from page 81</i>
[5]	Sash bearing → <i>from page 83</i>
[6]	Topglider → <i>from page 84</i>

Application range

Application range		
	Sash rebate width	240 – 1800 mm
	Sash rebate height	240 – 1800 mm





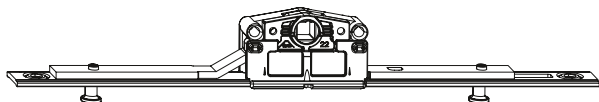





3.2.2 Standard espagnolette



Product description

- Basic security due to mushroom cams
- Gasket compression adjustment ± 1.0 mm

								N ^o
20	240	240 – 400	240 – 400	8	2	P	10 Piece(s)	736364
	400	400 – 600	400 – 600	8	2	P	10 Piece(s)	736375
	600	600 – 800	600 – 800	8	2	P	10 Piece(s)	736376
	800	800 – 1000	800 – 1000	8	2	P	10 Piece(s)	736377
	1000	1000 – 1200	1000 – 1200	8	3	P	10 Piece(s)	736378
	1200	1200 – 1800	1200 – 1800	8	3	P	10 Piece(s)	736379
	240	240 – 400	240 – 400	8.5	2	P	10 Piece(s)	641980
	400	400 – 600	400 – 600	8.5	2	P	10 Piece(s)	641982
	600	600 – 800	600 – 800	8.5	2	P	10 Piece(s)	641983
	800	800 – 1000	800 – 1000	8.5	2	P	10 Piece(s)	641984
	1000	1000 – 1200	1000 – 1200	8.5	3	P	10 Piece(s)	641985
	1200	1200 – 1800	1200 – 1800	8.5	3	P	10 Piece(s)	641986
	240	240 – 400	240 – 400	10.5	2	P	10 Piece(s)	641987
	400	400 – 600	400 – 600	10.5	2	P	10 Piece(s)	641988
	600	600 – 800	600 – 800	10.5	2	P	10 Piece(s)	641989
	800	800 – 1000	800 – 1000	10.5	2	P	10 Piece(s)	641990
1000	1000 – 1200	1000 – 1200	10.5	3	P	10 Piece(s)	641991	
1200	1200 – 1800	1200 – 1800	10.5	3	P	10 Piece(s)	641992	

								Nº
22	240	240 – 400	240 – 400	8	2	P	10 Piece(s)	736357
	400	400 – 600	400 – 600	8	2	P	10 Piece(s)	736358
	600	600 – 800	600 – 800	8	2	P	10 Piece(s)	736359
	800	800 – 1000	800 – 1000	8	2	P	10 Piece(s)	736361
	1000	1000 – 1200	1000 – 1200	8	3	P	10 Piece(s)	736362
	1200	1200 – 1800	1200 – 1800	8	3	P	10 Piece(s)	736363
	240	240 – 400	240 – 400	8.5	2	P	10 Piece(s)	641958
	400	400 – 600	400 – 600	8.5	2	P	10 Piece(s)	641959
	600	600 – 800	600 – 800	8.5	2	P	10 Piece(s)	641960
	800	800 – 1000	800 – 1000	8.5	2	P	10 Piece(s)	641961
	1000	1000 – 1200	1000 – 1200	8.5	3	P	10 Piece(s)	641962
	1200	1200 – 1800	1200 – 1800	8.5	3	P	10 Piece(s)	641963
	240	240 – 400	240 – 400	10.5	2	P	10 Piece(s)	641964
	400	400 – 600	400 – 600	10.5	2	P	10 Piece(s)	641975
	600	600 – 800	600 – 800	10.5	2	P	10 Piece(s)	641976
	800	800 – 1000	800 – 1000	10.5	2	P	10 Piece(s)	641977
	1000	1000 – 1200	1000 – 1200	10.5	3	P	10 Piece(s)	641978
	1200	1200 – 1800	1200 – 1800	10.5	3	P	10 Piece(s)	641979



INFO

The sash size generally depends on the configuration of the friction stays.



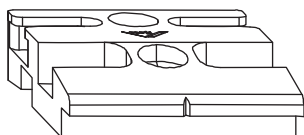

3.2.3 Strikers







Product description

- Integrated night ventilation

PVC strikers

				Nº
Epwin Group Profile 22	22.00	12	100 Piece(s)	367147
Epwin Group Spectus Elite 70	36.00	12	100 Piece(s)	387943
Eurocell Eurologik 70	22.40	12	100 Piece(s)	623115
Deceuninck 3000	21.00			
Deceuninck Traditional 2500	20.50	12	100 Piece(s)	770684
Liniar Sculptured Casement	23.00	12	100 Piece(s)	2000259
Rehau S 706	40.80	12	50 Piece(s)	450159
Synseal Synerjy	30.25	12	100 Piece(s)	492783
Veka Matrix FS 70	21.50	12	100 Piece(s)	502047
Veka Matrix 70	21.50	12	300 Piece(s)	891795
WHS Halo System 10	21.50	12	100 Piece(s)	622788
WHS Halo Eclipse	32.70	12	100 Piece(s)	367154
WHS Halo Esthetique				



				N ^o
WHS Halo Rustique 2	21.50	12	50 Piece(s)	561178



INFO

- The information in the above table is based on a theoretical profile assessment of the design drawings, which shows the geometric compatibility of the strikers and the profiles listed. General window properties cannot be derived from this. The general window properties are the sole responsibility of the window manufacturer.
- Strikers for further profiles are available upon request.



3.3 Roto TSL

3.3.1 Hardware overviews



INFO

All hardware overviews shown in this chapter are for illustration purposes only. Please refer to the applicable installation instructions for exact specifications and installation advice.





3.3.1.1 TSL

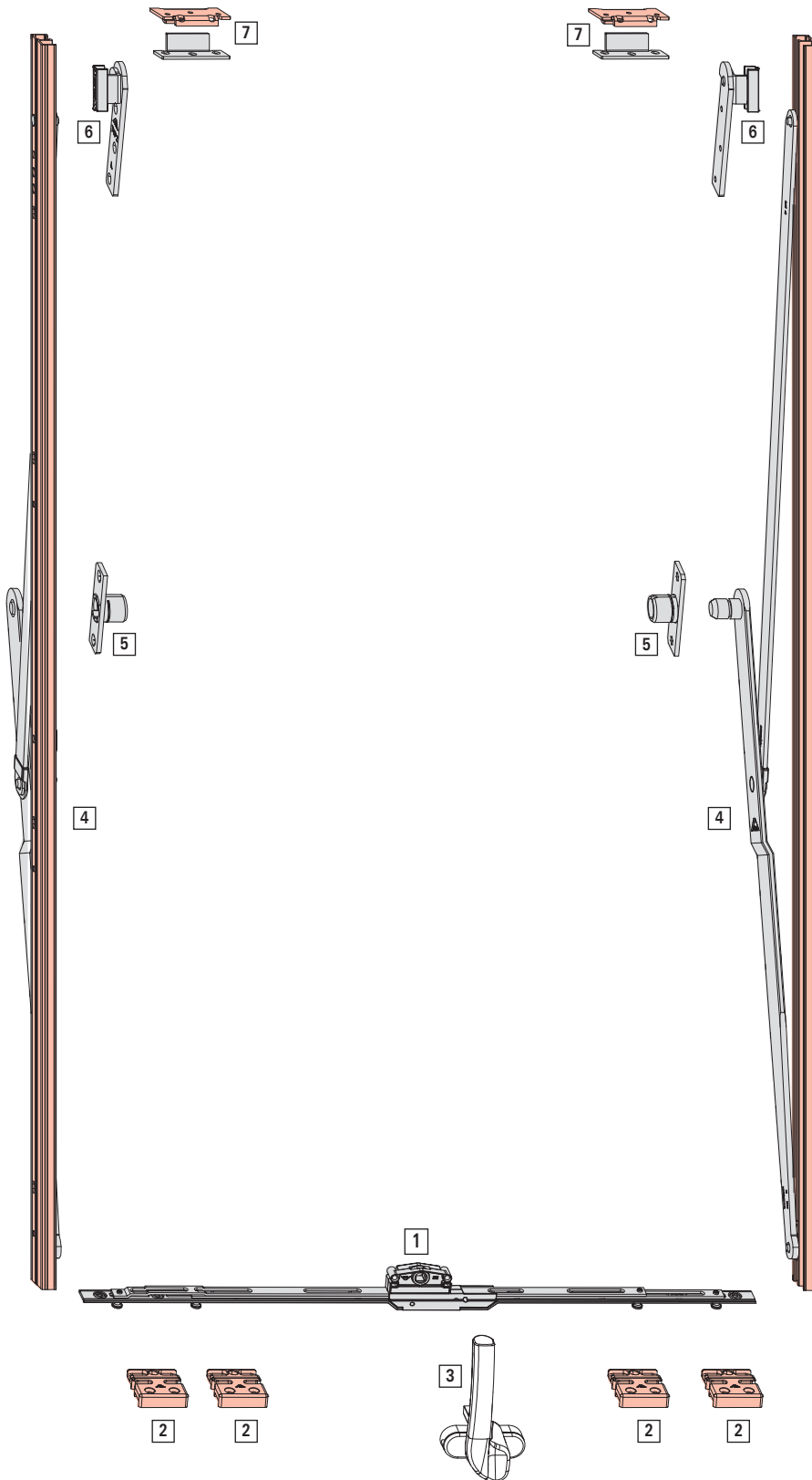

Position	Description
[1]	Espagnolette → <i>from page 97</i>
[2]	Strikers → <i>from page 98</i>
[3]	Handle, see CTL_1

Position	Description
[4]	Friction stay → <i>from page 52</i> Fully reversible hinge → <i>from page 81</i>
[5]	Sash bearing → <i>from page 83</i>
[6]	Topglider → <i>from page 84</i>
[7]	Burglary protection → <i>85</i>

Application range











Application range		
	Sash rebate width	305 – 1600 mm
	Sash rebate height	851 – 1600 mm

3.3.2 Reverse-action espagnolette – fixed handle height



Product description

- High level of burglary protection due to reverse-action mushroom cams
- Integrated gasket compression adjustment ± 1.0 mm
- Night ventilation in conjunction with striker with night ventilation function

									
20	850	851 – 950	851 – 950	205	8	6	P	10 Piece(s)	775866
	950	951 – 1050	951 – 1050	205	8	6	P	10 Piece(s)	775887
	1050	1051 – 1150	1051 – 1150	205	8	6	P	10 Piece(s)	775891
	1150	1151 – 1600	1151 – 1600	205	8	6	P	10 Piece(s)	775895
	850	851 – 950	851 – 950	205	9.5	6	P	10 Piece(s)	775885
	950	951 – 1050	951 – 1050	205	9.5	6	P	10 Piece(s)	775889
	1050	1051 – 1600	1051 – 1600	205	9.5	6	P	10 Piece(s)	775893
	1150	1151 – 1600	1151 – 1600	205	9.5	6	P	10 Piece(s)	775897
22	850	851 – 950	851 – 950	205	8	6	P	10 Piece(s)	775867
	950	951 – 1050	951 – 1050	205	8	6	P	10 Piece(s)	775888
	1050	1151 – 1600	1151 – 1600	205	8	6	P	10 Piece(s)	775892
	1150	1151 – 1600	1151 – 1600	205	8	6	P	10 Piece(s)	775896
	850	851 – 950	851 – 950	205	9.5	6	P	10 Piece(s)	775886
	950	951 – 1050	951 – 1050	205	9.5	6	P	10 Piece(s)	775890
	1050	1051 – 1150	1051 – 1150	205	9.5	6	P	10 Piece(s)	775894
	1150	1151 – 1600	1151 – 1600	205	9.5	6	P	10 Piece(s)	775898



INFO

The sash size generally depends on the configuration of the friction stays.



3.3.3 Reverse-action espagnolette – centred / variable handle height

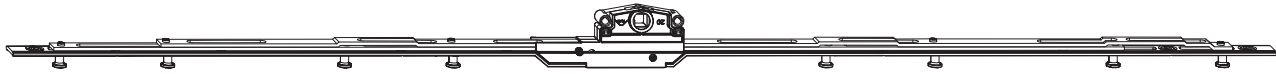

Product description

- High level of burglary protection due to reverse-action mushroom cams
- Gasket compression adjustment ± 1.0 mm
- Night ventilation in conjunction with striker with night ventilation function



20	306	305 – 400	305 – 400	-	8	4	P	10 Piece(s)	738741
	400	401 – 550	401 – 550	-	8	4	P	10 Piece(s)	738742
	750	551 – 750	551 – 400	-	8	4	P	10 Piece(s)	738743
	750	751 – 850	751 – 850	-	8	8	P	10 Piece(s)	738744
	850	851 – 950	851 – 950	-	8	8	P	10 Piece(s)	738785
	950	951 – 1050	951 – 1050	-	8	8	P	10 Piece(s)	738786
	1050	1051 – 1150	1051 – 1150	-	8	8	P	10 Piece(s)	738787
	1150	1151 – 1600	1151 – 1600	-	8	8	P	10 Piece(s)	738788
	305	305 – 400	305 – 400	-	9.5	4	P	10 Piece(s)	738789
	400	401 – 550	401 – 550	-	9.5	4	P	10 Piece(s)	738790
	750	551 – 750	551 – 400	-	9.5	4	P	10 Piece(s)	738791
	750	751 – 850	751 – 850	-	9.5	8	P	10 Piece(s)	738792
	850	851 – 950	851 – 950	-	9.5	8	P	10 Piece(s)	738793
	950	951 – 1050	951 – 1050	-	9.5	8	P	10 Piece(s)	738794
1050	1051 – 1150	1051 – 1150	-	9.5	8	P	10 Piece(s)	738795	
1150	1151 – 1600	1151 – 1600	-	9.5	8	P	10 Piece(s)	738796	
22	400	401 – 550	401 – 550	-	10.5	4	P	10 Piece(s)	794067
	600	551 – 750	551 – 750	-	10.5	4	P	10 Piece(s)	794068
	800	751 – 850	751 – 850	-	10.5	8	P	10 Piece(s)	794069
	900	851 – 950	851 – 950	-	10.5	8	P	10 Piece(s)	794070
	1000	951 – 1050	951 – 1050	-	10.5	8	P	10 Piece(s)	794071
	1100	1051 – 1150	1051 – 1150	-	10.5	8	P	10 Piece(s)	794072
	1200	1151 – 1600	1151 – 1600	-	10.5	8	P	10 Piece(s)	794073
	305	305 – 400	305 – 400	-	8	4	P	10 Piece(s)	738797
	400	401 – 550	401 – 550	-	8	4	P	10 Piece(s)	738798
	550	551 – 750	551 – 750	-	8	4	P	10 Piece(s)	738799
	750	751 – 850	751 – 850	-	8	8	P	10 Piece(s)	738800
	850	851 – 950	851 – 950	-	8	8	P	10 Piece(s)	738801
	950	951 – 1050	951 – 1050	-	8	8	P	10 Piece(s)	738802
	1050	1051 – 1150	1051 – 1150	-	8	8	P	10 Piece(s)	738803
	1150	1151 – 1600	1151 – 1600	-	8	8	P	10 Piece(s)	738804
	305	305 – 400	305 – 400	-	9.5	4	P	10 Piece(s)	738805
	400	401 – 550	401 – 550	-	9.5	4	P	10 Piece(s)	738806
	550	551 – 750	551 – 750	-	9.5	4	P	10 Piece(s)	738807
	750	751 – 850	751 – 850	-	9.5	8	P	10 Piece(s)	738808
	850	851 – 950	851 – 950	-	9.5	8	P	10 Piece(s)	738809
	950	951 – 1050	951 – 1050	-	9.5	8	P	10 Piece(s)	738810
	1050	1051 – 1150	1051 – 1150	-	9.5	8	P	10 Piece(s)	738811
1150	1151 – 1600	1151 – 1600	-	9.5	4	P	10 Piece(s)	738812	



INFO

The sash size generally depends on the configuration of the friction stays.

3.3.4 Strikers

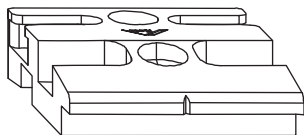

Product description

- Integrated night ventilation function

PVC strikers

					Nº
Epwin Group Profile 22	22.00	12	100 Piece(s)	367147	
Epwin Group Spectus Elite 70	36.00	12	100 Piece(s)	387943	
Eurocell Eurologik 70	22.40	12	100 Piece(s)	623115	
Deceuninck 3000	21.00				
Deceuninck Traditional 2500	20.50	12	100 Piece(s)	770684	
Linjar Sculptured Casement	23.00	12	100 Piece(s)	2000259	
Rehau S 706	40.80	12	50 Piece(s)	450159	
Synseal Synerjy	30.25	12	100 Piece(s)	492783	
Veka Matrix FS 70	21.50	12	100 Piece(s)	502047	
Veka Matrix 70	21.50	12	300 Piece(s)	891795	
WHS Halo System 10	21.50	12	100 Piece(s)	622788	
WHS Halo Eclipse	32.70	12	100 Piece(s)	367154	
WHS Halo Esthetique					



					Nº
WHS Halo Rustique 2	21.50	12	50 Piece(s)	561178	

Timber strikers

						Nº
Eurofalz Euronut 7/8 Euronut 11/8	21	-	12	Roto Sil	50 Piece(s)	502049



Packer

	Nº
Packer, 7° inclination	798172

Aluminium striker

			Nº
AluK Optio 58BW TSR top-swing-reversible	44	100 Piece(s)	794907



INFO

- The information in the above table is based on a theoretical profile assessment of the design drawings, which shows the geometric compatibility of the strikers and the profiles listed. General window properties cannot be derived from this. The general window properties are the sole responsibility of the window manufacturer.
- Strikers for further profiles are available upon request.

3.4 Roto TSH

3.4.1 Hardware overviews



INFO

All hardware overviews shown in this chapter are for illustration purposes only. Please refer to the applicable installation instructions for exact specifications and installation advice.

3.4.1.1 TSH

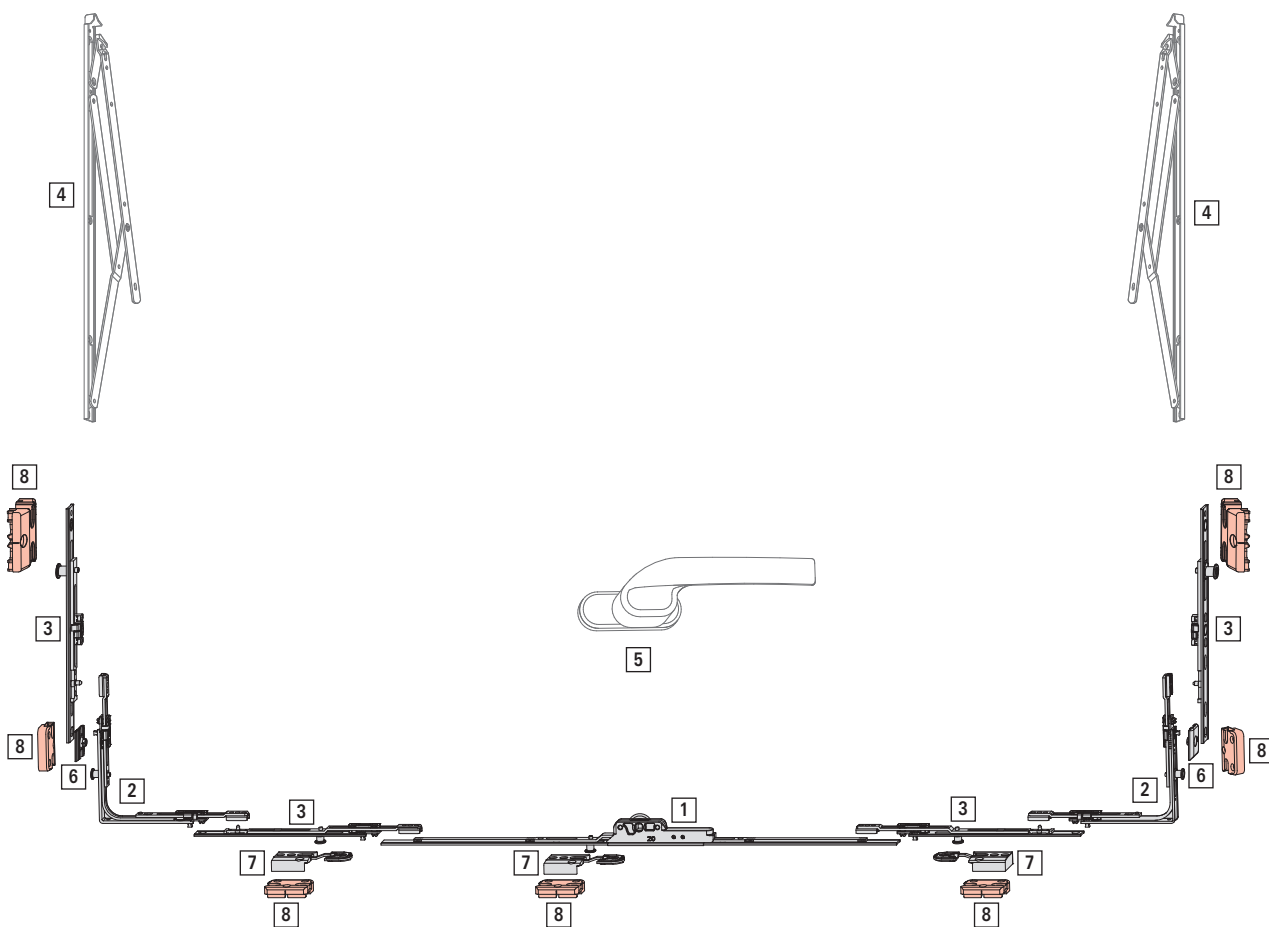

Position	Description
[1]	Espagnolette → <i>from page 101</i>
[2]	Corner drive → <i>from page 101</i>
[3]	Centre lock → <i>from page 102</i>
[4]	Friction stay → <i>from page 52</i> Fully reversible hinge → <i>from page 81</i>
[5]	Handle, see CTL_1
[6]	Rebate run-up block → <i>from page 103</i>
[7]	TurnPlus → <i>from page 103</i>
[8]	Strikers → <i>from page 102</i>

Application range

Application range	
	Sash rebate width
	851 – 1600 mm



Application range		
	Sash rebate height	851 – 1600 mm

3.4.2 Espagnolette

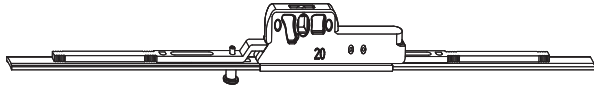

Product description

- Centred handle height
- Cropping range 2 x 2000 mm
- High level of burglary protection due to optional locking points
- Integrated gasket compression adjustment ± 0.8 mm
- 90° / 135° espagnolette lock-in position

					N ^o
20	800	1	P	10 Piece(s)	611958
22	800	1	P	10 Piece(s)	611959
25	800	1	P	10 Piece(s)	616428



INFO

The sash size generally depends on the configuration of the friction stays.



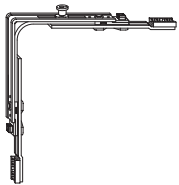



3.4.3 Corner drives

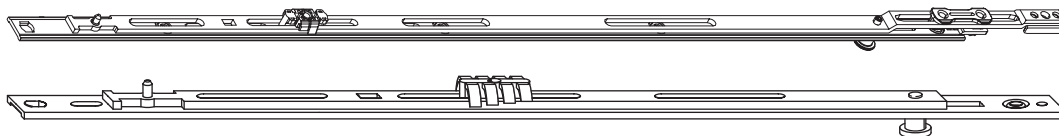

					N ^o
Special short corner drive	-	1	P	10 Piece(s)	260282
Standard corner drive	SRW / SRH > 621 mm	1	P	10 Piece(s)	260277





3.4.4 Multipart centre locks

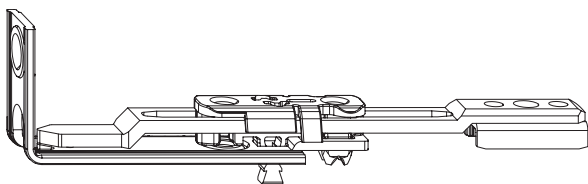

						Nº
N	200	1	P	Roto Sil	10 Piece(s)	255284
	200	1	V	Roto Sil	10 Piece(s)	296853
	400	1	P	Roto Sil	10 Piece(s)	255285
	400	1	V	Roto Sil	10 Piece(s)	296854
	600	1	P	Roto Sil	10 Piece(s)	255286
	600	1	V	Roto Sil	10 Piece(s)	296855
Y	200	-	-	Roto Sil	22 Piece(s)	308267
	200	1	P	Roto Sil	10 Piece(s)	622880
	400	1	P	Roto Sil	10 Piece(s)	622881
	600	1	P	Roto Sil	10 Piece(s)	622882





3.4.5 Shootbolt

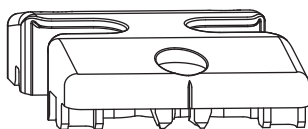

					Nº
Shootbolt for second opening sash	60	-	-		614319
Shootbolt with cam	-	1	E	10 Piece(s)	614320

3.4.6 Strikers



				Nº
Eurocell Eurologik 70	22.40	12	100 Piece(s)	616393
Kömmerling C70 Gold	20.50			
Epwin Group Spectus Elite 70	36.00	12	100 Piece(s)	616394
Synseal Synerjy	30.25	12	100 Piece(s)	616384
Veka Matrix 70	29.40	12	100 Piece(s)	616342
WHS Halo System 10	22.00	12	100 Piece(s)	616379
WHS Halo Rustique 2				
WHS Halo Eclipse	32.70	12	100 Piece(s)	616396
WHS Halo Esthetique				



INFO





Strikers for further profiles are available upon request.

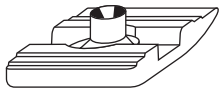

3.4.7 Accessories

3.4.7.1 Rebate run-up block







					N ^o
Rebate run-up block		Sash	21	12	350402
Rebate run-up block		Sash	21	13	350403

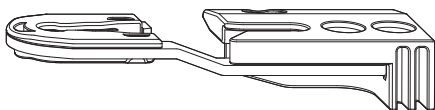



3.4.7.2 Turn Plus

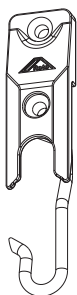

					N ^o
Eurocell Eurologik 70 Kömmerling C70 Gold Rehau S 706 Selecta Systems Advanced 70		22.40 20.50 42.50 40.80	Right	30 Piece(s)	616361
			Left	30 Piece(s)	616362
			Right	30 Piece(s)	616363
			Left	30 Piece(s)	616364
Synseal Synerjy		30.25	Right	30 Piece(s)	616328
			Left	30 Piece(s)	616329
Veka Matrix 70		29.40	Right	30 Piece(s)	616340
			Left	30 Piece(s)	616341
WHS Halo Eclipse WHS Halo Esthetique		32.70	Right	30 Piece(s)	616377
			Left	30 Piece(s)	616378



				N ^o
Lever		Roto Sil	Left	630502
		Roto Sil	Right	630501



INFO

No additional sash component is required. A V cam of a component is used as the sash component.

Packer



	Nº
Support for Euro-groove 7 / 8	375930

3.4.7.3 Croppers

			Nº
Pneumatic punch – PS 100	Left	1 Piece(s)	553992
Pneumatic punch – PS 100	Right	1 Piece(s)	553993
Foot control for pneumatic punch	–	1 Piece(s)	554096
Hand control for pneumatic punch	–	1 Piece(s)	554097



3.5 Roto AL

3.5.1 Cam

Cam, insertable



		Nº
Insertable	100 Piece(s)	334671

For use with strikers V.01 and V.02 → *from page 105.*

SEC cam

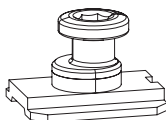





			Nº
SEC cam RC2	Insertable	100 Piece(s)	447114

For use with the SEC striker → *from page 105.*

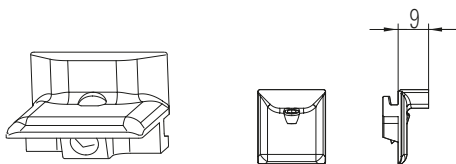
3.5.2 Strikers

Striker V.01 and V.02



				Nº
Clampable	V.01	9	100 Piece(s)	728918
Clampable	V.02	9	100 Piece(s)	728920

For use with the cam, insertable → *from page 105.*

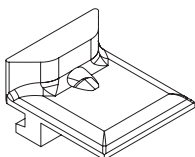





				Nº
Clampable	V.01	8	100 Piece(s)	728917

				Nº
Clampable	V.02	8	100 Piece(s)	728919

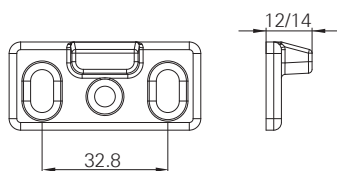
For use with the cam, insertable → *from page 105.*

Striker TH aluminium OO



			Nº
Striker, 12 mm	Screw-on	100 Piece(s)	482261
Striker, 14 mm	Screw-on	100 Piece(s)	482262

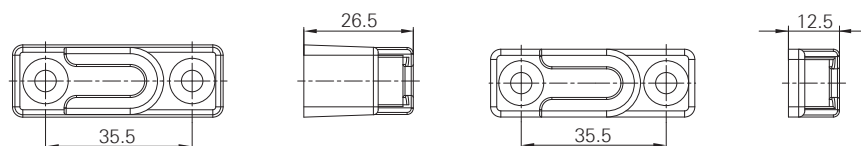

Striker aluminium OO

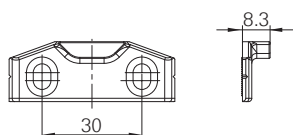

			Nº
Striker, 26.5 mm	Screw-on	100 Piece(s)	482259
Striker, 12.5 mm	Screw-on	100 Piece(s)	482260

Striker aluminium 100



			Nº
Aluminium striker 100	Screw-on	100 Piece(s)	212761

Packer aluminium 100



		Nº
Aluminium support 100	100 Piece(s)	212773



SEC striker

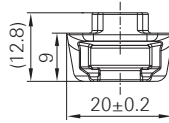
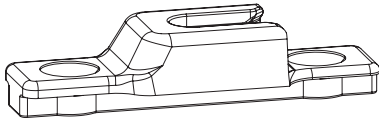

				Nº
Screw-on	V.01	9	100 Piece(s)	212637
Screw-on	V.02	9	100 Piece(s)	212638



For use with the SEC cam → *from page 105.*



INFO

Strikers for further profiles are available upon request.

3.5.3 Corner drive without blocking device

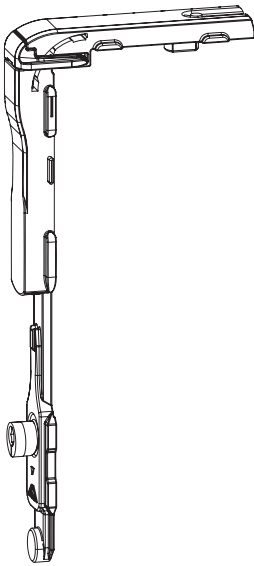

					Nº
Corner drive without blocking device, with retaining fork	110 / 10	1	E	50 Piece(s)	728844

Can be used for sash profiles with 15/20 groove.

3.5.4 Flush-encased gearbox

3.5.4.1 Flush-encased gearbox

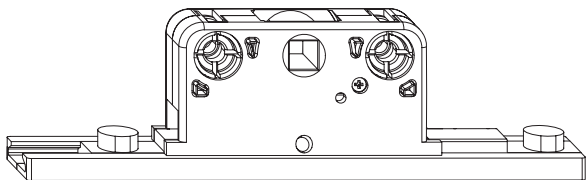

Product description

- Backset 25 / 30 mm
- 10 mm coupling points

			N ^o
25	Clampable lug	10 Piece(s)	487489
30	Clampable lug	10 Piece(s)	487490

3.5.4.2 Flush-encased reverse-action espagnolette

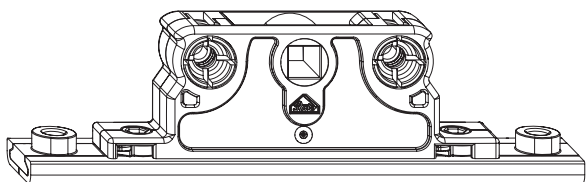

Product description

- Backset 22 / 30 mm
- 10 mm coupling points

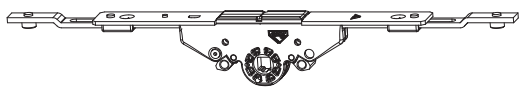

			N ^o
22	Clampable lug	Left	493590
	Clampable lug	Right	487491
30	Clampable lug	Left	493591
	Clampable lug	Right	487493

3.5.4.3 Flush-encased gearbox



			N ^o
30	280	1 Piece(s)	625431
35	280	1 Piece(s)	625432







			Nº
40	280	1 Piece(s)	625433

3.5.4.4 Rebate espagnolette

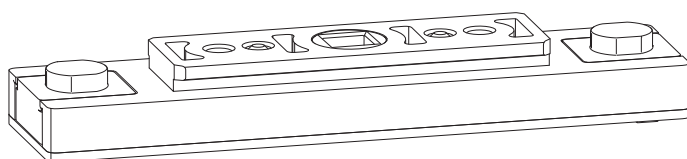
Product description

- Can be used for Euro-groove 15/20
- Right-hand version
- 10 mm coupling points



			Nº
Rebate espagnolette	Max. 4 locking points	1 Piece(s)	606418

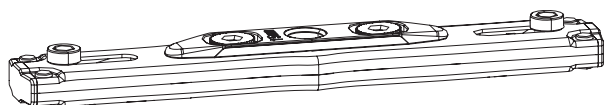

			Nº
Rebate espagnolette	> 4 locking points	1 Piece(s)	623066

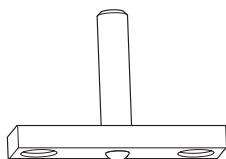

3.5.5 T connectors



		Nº
25	200 Piece(s)	739481
32	200 Piece(s)	739478
37	200 Piece(s)	739479
47	200 Piece(s)	739480

3.5.6 TH connector



		Nº
Coupling point, 10 mm	100 Piece(s)	482264

3.5.7 Coupler component set





		Nº
Coupler component set	For coupling a connecting rod	100 Piece(s)
		728856

Contents

Figure	Quantity	Description
	2	SEC connector
	1	SEC coupler component, plate
	2	Cylinder screw M5 x 6
	2	Washer (not sh.)

3.5.8 Connecting rod



		Nº
3 m connecting rod	ECC-groove	1 Piece(s)
6 m connecting rod	ECC-groove	1 Piece(s)
		735102
		334665



Roto Frank
Fenster- und Türtechnologie GmbH

Wilhelm-Frank-Platz 1
70771 Leinfelden-Echterdingen
Germany

Phone +49 (0) 711 7598 0
Fax +49 (0) 711 7598 253
info@roto-frank.com

www.roto-frank.com

From a single source: Optimum hardware systems to meet all challenges

- Roto Window** | Hardware systems for windows and balcony doors
- Roto Sliding** | Hardware systems for large sliding windows and doors
- Roto Door** | Matching hardware technology everything about doors
- Roto Equipment** | Additional technology for windows and doors